

# **EUROFAST<sup>®</sup>**

*“Fixed quality”*

---

## **MECHANICAL FASTENING SOLUTIONS FOR FLAT ROOF**

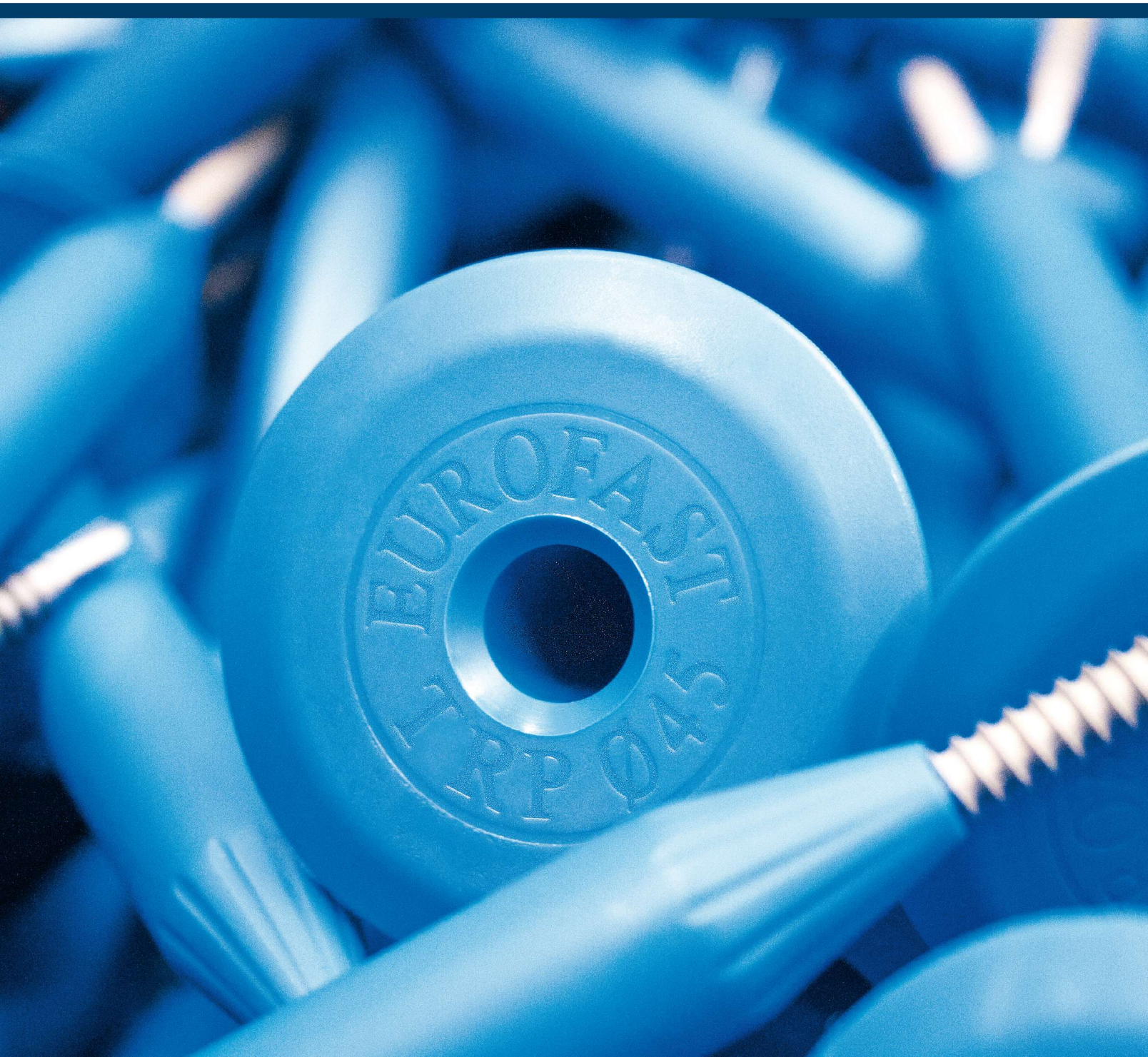

# Our Sales Team

## ORDERING

E-mail [sales@eurofastgroup.com](mailto:sales@eurofastgroup.com)

Telephone +31 493 31 58 85

## DELIVERY

The Sales Team must receive the order in time and goods need to be in stock. If the goods aren't in stock, the Sales Team will inform you about the expected delivery date.

### Disclaimer

Images in this catalogue may be different from the actual product.  
Subject to misprints, errors and technical modifications.  
Eurofast reserves the right to change this information at any time.

# Index

<b>01</b>	Introduction	Page 4
<b>02</b>	Roofing fasteners for steel substrates	Page 14
<b>03</b>	Roofing fasteners for wood substrates	Page 66
<b>04</b>	Roofing fasteners for lightweight concrete substrates	Page 88
<b>05</b>	Roofing fasteners for concrete substrates	Page 104
<b>06</b>	Roofing fasteners for cementitious wood fibre substrates	Page 138
<b>07</b>	Tube washers and pressure plates	Page 142
<b>08</b>	Universal applications	Page 166
<b>09</b>	Tools & Accessories	Page 172
<b>10</b>	Ergonomic installation equipment	Page 178

*We increase the ease: A colour coded lid per substrate.*



**EUROFAST®**

## Introduction



## Introduction

Your partner in mechanical fastening solutions for the building envelope.

Eurofast is manufacturer of the leading brand Eurofast® and a full-service technical consultancy firm, for mechanically fastening the building envelope.

At Eurofast we strive to unburden our customers as much as possible in their process of finding the best suitable mechanical fastening solution, for their specific situation. This ensures that every building envelope is fastened to the highest possible standard.

We offer a wide range of fastening solutions for mechanically fastening Flat roof and cladding constructions of industrial and commercial buildings. Complemented with a full-service package installation equipment and necessities to support you at every step of the fastening process.

## Introduction

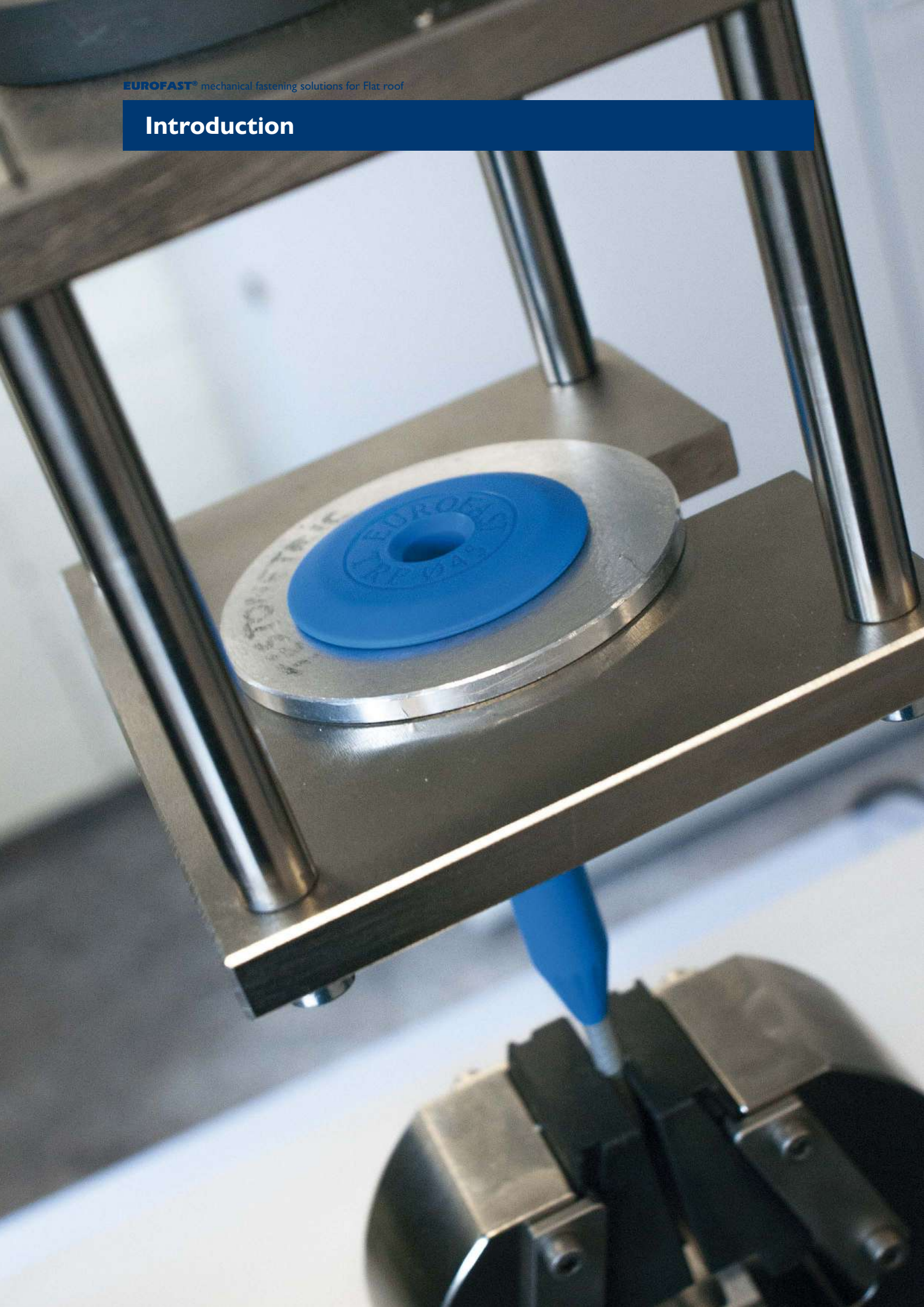

## Introduction

### **Eurofast**

was established in 1977, in the Netherlands. Furthermore we have Business Units and divisions in Hungary, Poland, Belgium, United Kingdom and Denmark. Making it possible for us to serve more than 25 European countries.

Every fastening project is unique and comes with different needs in terms of products and services. At Eurofast we are well aware of this and help you with customised advice for your specific situation. Keeping in mind a country's individual approach to fastening and your preferences. We help you in finding the solution for your project.

We are proud to present to you our fully updated catalogue.

If there are any questions, please do not hesitate to contact our Team.

Kjell Verdonschot  
Chief Executive Officer C.E.O.



## Introduction



## Quality Centre

All of the fastening solutions of Eurofast meet the highest international requirements and standards. To guarantee these requirements and standards and to ensure that our customers always receive high quality products, we perform nonstop quality control on our production products in our Quality Centre.

## BIM

Eurofast is BIM-Ready. We offer you the possibility to use BIM-data and BIM-content of our Eurofast fasteners. Eurofast provides you with all the essential information of our fasteners, which is necessary for creating a complete BIM-model of your roof system or cladding construction. We are here to advise you on the most suitable fastener for your application. Hereafter you will receive the customised BIM-model of the fastener. For questions about BIM you can contact us via: [bim@eurofastgroup.com](mailto:bim@eurofastgroup.com).



## Introduction

# Certifications

Eurofast has obtained the following certifications:

### EOTA CE

ETA-06/007

### FM Approval

Approval Identification 3049679 + 452785

### SINTEF

Certification 2607

### ÉMI Non-profit Llc.

A-42/2018

The current certifications are available on our website.



Approval Identification: 3049679 + 452785

## FM Approval

We have obtained **FM Approval** on various products from our Eurofast program.

This leading American insurance company is globally recognized as a required indication for quality and safety by many international companies.

Overview of products which are included in the certification:

#### Screws

- EDS-S 4.8
- EDS-B 4.8
- EFHD 6.3
- EDS-BZT
- EDS-BGT

#### Tube washer combinations

- TRPS-45
- TRPB-45
- TRPSG-45
- TRPBG-45
- TLKEFHD-45
- TLKEFHD-75

#### Pressure plates

- DVP-EFB-51NS
- DVPEFZK8240D

For all your questions about FM projects, please contact your Sales Representative, our Internal Sales **+31 493 31 58 85** or [sales@eurofastgroup.com](mailto:sales@eurofastgroup.com)

## Introduction

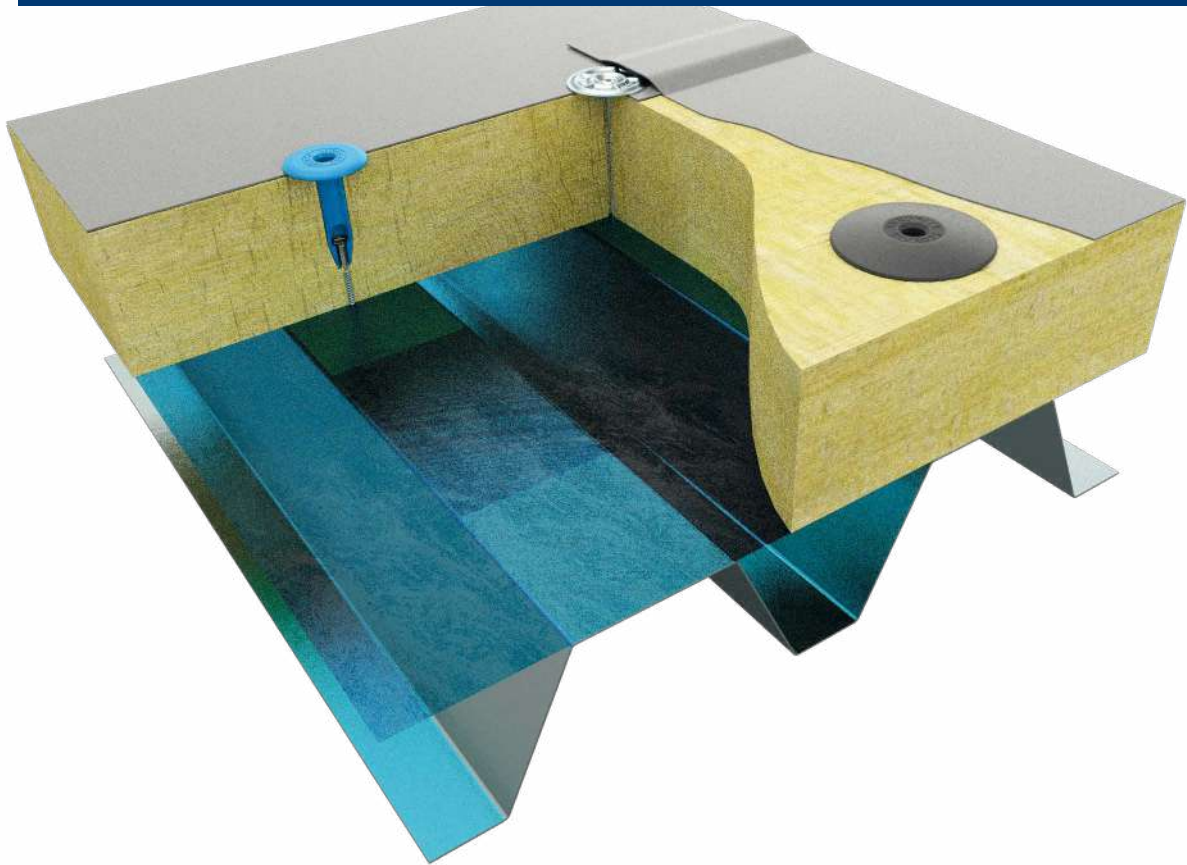

## Product development

At Eurofast we strive to unburden you as much as possible in finding the best suitable solution for your fastening situation. As part of doing so, we are constantly looking to improve our products, modify current products to fit to the changing needs or creating completely new products. All with the goal in mind to offer added value to our customers, in terms of application and quality.

This development goes far beyond just our fastening systems. We also develop tools and machines to assist you with the correct application/installation of these systems.

## Technical Department

The technical department can support you in restoring and maintaining your tools. They can also provide information regarding leasing one of our automatic machines.

## Mini-wind up lifter

Eurofast has the resources to produce a mini wind load test of their own. This mini-wind up lifter gives us the ability to test, together with the customer and suppliers, a specific combination of products to determine if this combination gives the results requested.

## Introduction



## Technical Support & Services

As a full-service technical consultancy company, we offer a total service package to support you at every step of the fastening process. New-builds as well as refurbishments. We provide wind load and tapered insulation calculations. We perform pull-out tests and provide customised advice concerning correctly fastening your project. Request calculations and other Support & Services via our website

[www.eurofastgroup.com](http://www.eurofastgroup.com).

## Thermal Bridging

Currently, and in the future, the insulation thickness is likely to increase because of changing building regulations. Therefore the cold-bridge effect of fasteners becomes a very critical and important issue. By using steel screws and steel decking plates in insulated roofs; the cold-bridge effect is at its greatest. To compensate this loss, the thickness of the insulation has to be increased. An alternative and more cost effective solution is to use a plastic decking plate with steel screw. Eurofast has developed their tube system, which consists of high-grade polyamide (PA6), or a polypropylene (PP). These materials prevent the cold-bridge effect and resist extreme temperature fluctuations and mechanical stresses in the systems.

## Characteristic values

Washer	Steel deck 0,7 - 0,88 mm		Steel deck 0,7 - 2x 1,25 mm				Steel deck 3,0 mm	Steel deck ≥ 0.63 - 2x 1,25 mm	
	EDS-S-48	EFHD-63	EDS-BZT-48 EDS-BGT-48	EDS-BZTR-48 EDS-BGTR-48	EDS SRB-48	EDS-B-48	EDS-B-55	EDS-BZTHD-48 EDS-BGTHD-48	DFHD-67
DVP-EF/DF-8240D/R	1370	1320	1230	1090	1030	1390	1390	1680	
DVP-EFB/DFB-8240D/H	1280	1280	1280	1090	1030	1280	1280	1280	
DVPEFZK8240D			1340	1090				4150	
DVP-EF-5010N/D	1370	1320	1320	1090	1030	1390	1390	1940	1860
DVP-EF-5010DFR	1370								
DVP-EF-4010N/N3									
DVP-K-4040H	1490								
DVP-EF-7007N/D/H	1490	1320	1340	1090	1030	1390	1390	3910	
DVP-EF-7010 N/D	1490	1320	1340	1090	1030	1390	1390	3910	1860
DVP-EF-7010DFR	1490								
DVP-EF/DF-7070 D			1340	1090				3910	
DVP-EF-8040D/N	1490	1320	1320	1090	1030	1310	1310	3510	
DVP-EF-8240XH	1490		1320	1090	1030	1310	1310	3510	
DVP-EF-7005D/N	1290				1030	1290	1290		
DVP-DF-8240H/XH	1490	1320	1320	1090	1030	1310	1310	3510	
DVP-EFB-51NS	1490	1320			1030	1390	1390		1860
DVP-EF-51N	1490	1320			1030	1390	1390		1860
EDF-BAR-F/FB	1110	1110	1110	1110	1030	1110	1110	1110	
KMT/DVPMKMT-8240	1490	1320			1490	1490	1490		

### Tube washers

TWVP-8040xxx	1160				1030	1160	1160		
TLK-45xxx	1260	1260			1030	1260	1260		
TLK-75xxx	1260	1260			1030	1260	1260		
TRP-45xxx	1260				1030	1260	1260		
BTRP-45xxx	1260				1030	1260	1260		
BIO-45xxx	1260				1030	1260	1260		

### Tube washer/nail combinations

ISPC-50xxx									
ISPC-70N									
ISPC-A2									

## Characteristic values

Washer	Lightweight concrete			Concrete				Wood					
	GBSA2-60	GBS-60	GBS-80	ISPC	EFHD-63	DFCF-67	EFR-63	EAS-63	EDS-B-48	EDS-BZT-48 EDS-BGT-48	EDS-B-55	EDS-H-50	EFHD-63
DVP-EF/DF-8240D/R	1680	1440			1680	1680	1680						1680
DVP-EFB/DFB-8240D/H					1280	1280	1280		1280	1280	1280	1280	1280
DVPEFZK8240D									1330	1330	1530	1330	
DVP-EF-5010N/D	1940	1440			1490	1940	1720		1330	1330	1330	1340	1500
DVP-EF-5010DFR	1940	1440							1330	1330	1330	1330	
DVP-EF-4010N/N3	1200	1200										1200	
DVP-K-4040H													
DVP-EF-7007N/D/H	1940	1440			3510	3910	1720		1330	1330	1330	1330	1950
DVP-EF-7010 N/D	1940	1440			3510	3910	1720		1330	1330	1330	1330	1950
DVP-EF-7010DFR	1940	1440							1330	1330	1330	1330	
DVP-EF/DF-7070 D	1940	1440			3510	3910	1720		1330	1330	1350	1340	
DVP-EF-8040D/N													
DVP-EF-8240XH									1330	1330	1330	1330	
DVP-EF-7005D/N									1290	1290	1290	1290	
DVP-DF-8240H/XH	1940	1940			3510	3910	1720		1330	1330	1330	1330	1950
DVP-EFB-51NS	1860	1440			1860	1860	1720		1330		1330	1330	1860
DVP-EF-51N	1860	1440			1860		1720		1330		1330	1330	1860
EDF-BAR-F/FB	1110	1110	1110		1110		1110		1110	1110	1110	1110	1110
KMT/DVPKMT-8240	1490	1440			1490		1490		1330		1490	1340	1490

### Tube washers

TWP-8040xxx									1160		1160	1160	1160
TLK-45xxx	1720	1390	1390		1510		1260	1540	1330		1330	1150	1720
TLK-75xxx	1150	1150	1150		1510		1260	1540	1150		1150	1150	1150
TRP-45xxx					2990		1260	3000	1260		1260	1260	
BTRP-45xxx					2990		1260	3000	1260		1260	1260	
BIO-45xxx	1510	1440					1260	1260				1260	

### Tube washer/nail combinations

ISPC-50xxx				1650									
ISPC-70N				1750									
ISPC-A2				1720									

## Roofing fasteners for steel substrates

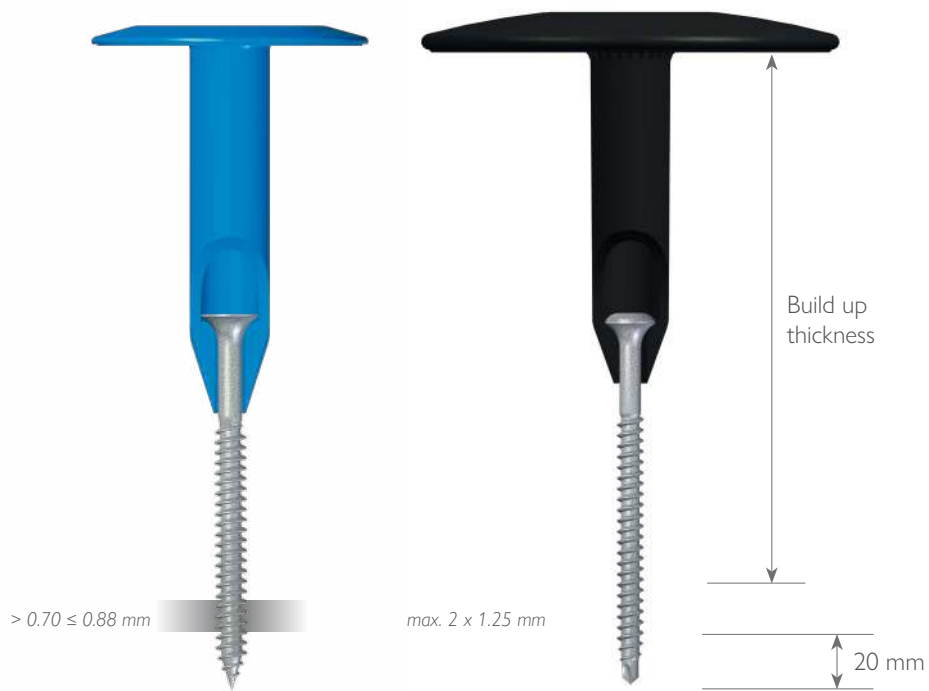
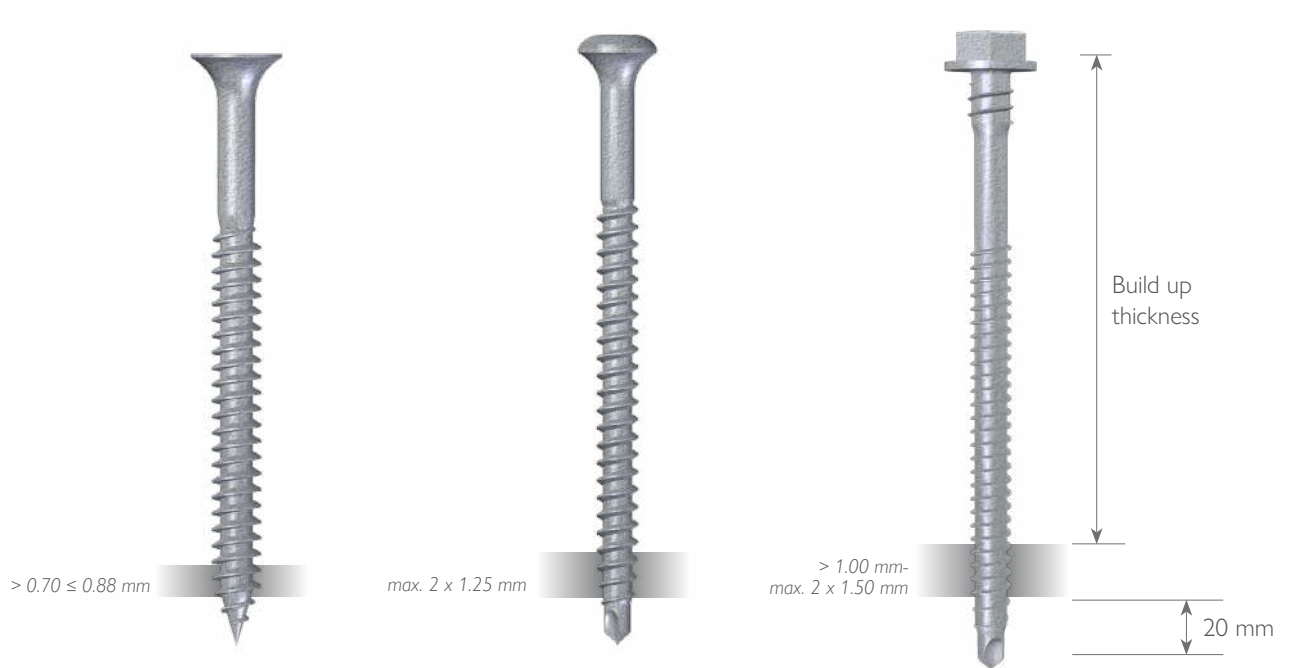

# Roofing fasteners for steel substrates

## 15 cycles Kesternich

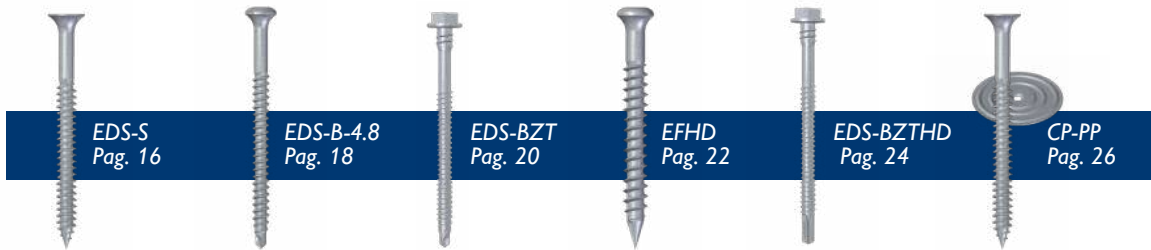

## 30 cycles Kesternich

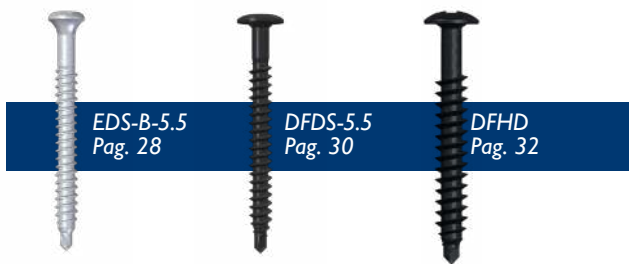

## Bi-Metal



## 15 cycles Kesternich - Tube washer combination

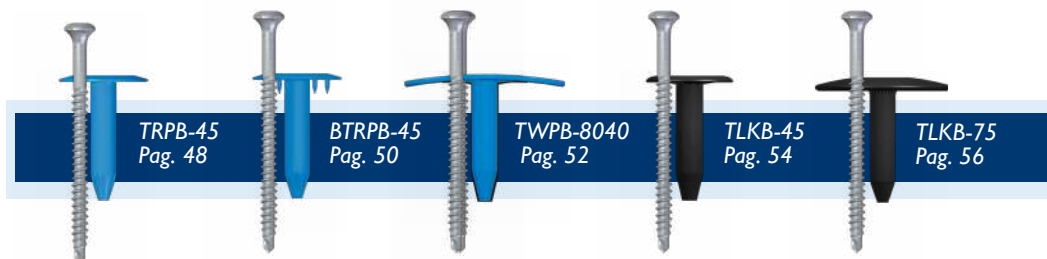
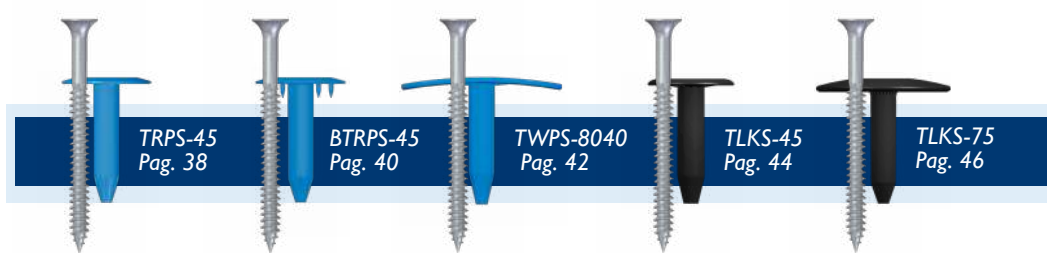

## Bi-Metal - Tube washer combination



**Steel substrates > 0.70 ≤ 0.88 mm**

# EUROFAST® EDS-S

**15 CYCLES KESTERNICH**

PH2 drive  
Incl. EF-head mark

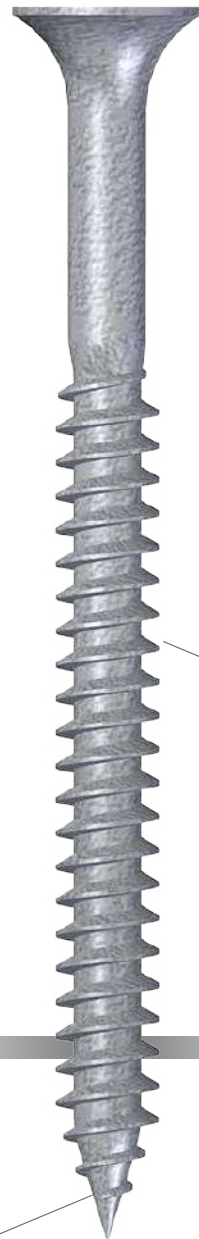

**Material**  
Zinc plated with  
Magni-Silver coating

**Steel thickness**  
> 0.70 ≤ 0.88 mm



**Recommended  
length of transfix**  
20 mm through the  
steel roofing plate

**Point**  
Hardened S-Point



## Steel substrates > 0.70 ≤ 0.88 mm

Product key	Dimensions			☒
	Ø	Screw	Thread	
EDS-S-48025	4.8	25	20	1000
EDS-S-48030	4.8	30	25	1000
EDS-S-48040	4.8	40	35	1000
EDS-S-48050	4.8	50	45	1000
EDS-S-48060	4.8	60	55	500
EDS-S-48070	4.8	70	60	500
EDS-S-48080	4.8	80	70	500
EDS-S-48090	4.8	90	80	500
EDS-S-48100	4.8	100	80	500
EDS-S-48110	4.8	110	80	500
EDS-S-48120	4.8	120	80	500
EDS-S-48130	4.8	130	80	500
EDS-S-48140	4.8	140	80	500
EDS-S-48150	4.8	150	80	500
EDS-S-48160	4.8	160	80	500
EDS-S-48170	4.8	170	80	500
EDS-S-48180	4.8	180	80	500
EDS-S-48200	4.8	200	80	500
EDS-S-48220	4.8	220	80	500
EDS-S-48240	4.8	240	80	500
EDS-S-48260	4.8	260	80	500
EDS-S-48280	4.8	280	80	500
EDS-S-48300	4.8	300	80	500

Steel substrates  $\leq$  max 2 x 1.25 mm

# EUROFAST® EDS-B-4.8

15 CYCLES KESTERNICH



Torx 25 drive  
Incl. EF-head mark

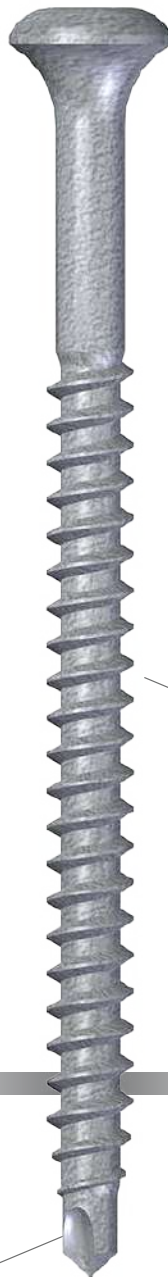

**Material**

Zinc plated with  
Magni-Silver coating

**Steel thickness**  
 $\leq$  max 2 x 1.25 mm

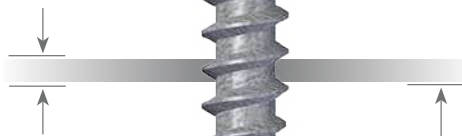

**Recommended  
length of transfix**  
20 mm through the  
steel roofing plate

**Point**

Reduced drill-point

## Steel substrates $\leq$ max 2 x 1.25 mm

Product key	Dimensions			☒
	Ø	Screw	Thread	
EDS-B-48035	4.8	35	30	1000
EDS-B-48050	4.8	50	45	1000
EDS-B-48060	4.8	60	50	1000
EDS-B-48070	4.8	70	50	1000
EDS-B-48080	4.8	80	50	1000
EDS-B-48090	4.8	90	50	1000
EDS-B-48100	4.8	100	80	500
EDS-B-48110	4.8	110	80	500
EDS-B-48120	4.8	120	80	500
EDS-B-48130	4.8	130	100	500
EDS-B-48140	4.8	140	100	500
EDS-B-48150	4.8	150	100	500
EDS-B-48180	4.8	180	120	500
EDS-B-48210	4.8	210	120	500
EDS-B-48240	4.8	240	120	500
EDS-B-48260	4.8	260	120	500
EDS-B-48280	4.8	280	120	500
EDS-B-48300	4.8	300	120	500

Steel substrates  $\leq$  max 2 x 1.25 mm

# EUROFAST® EDS-BZT

15 CYCLES KESTERNICH



### Extra option

Also belted available  
for machine processing

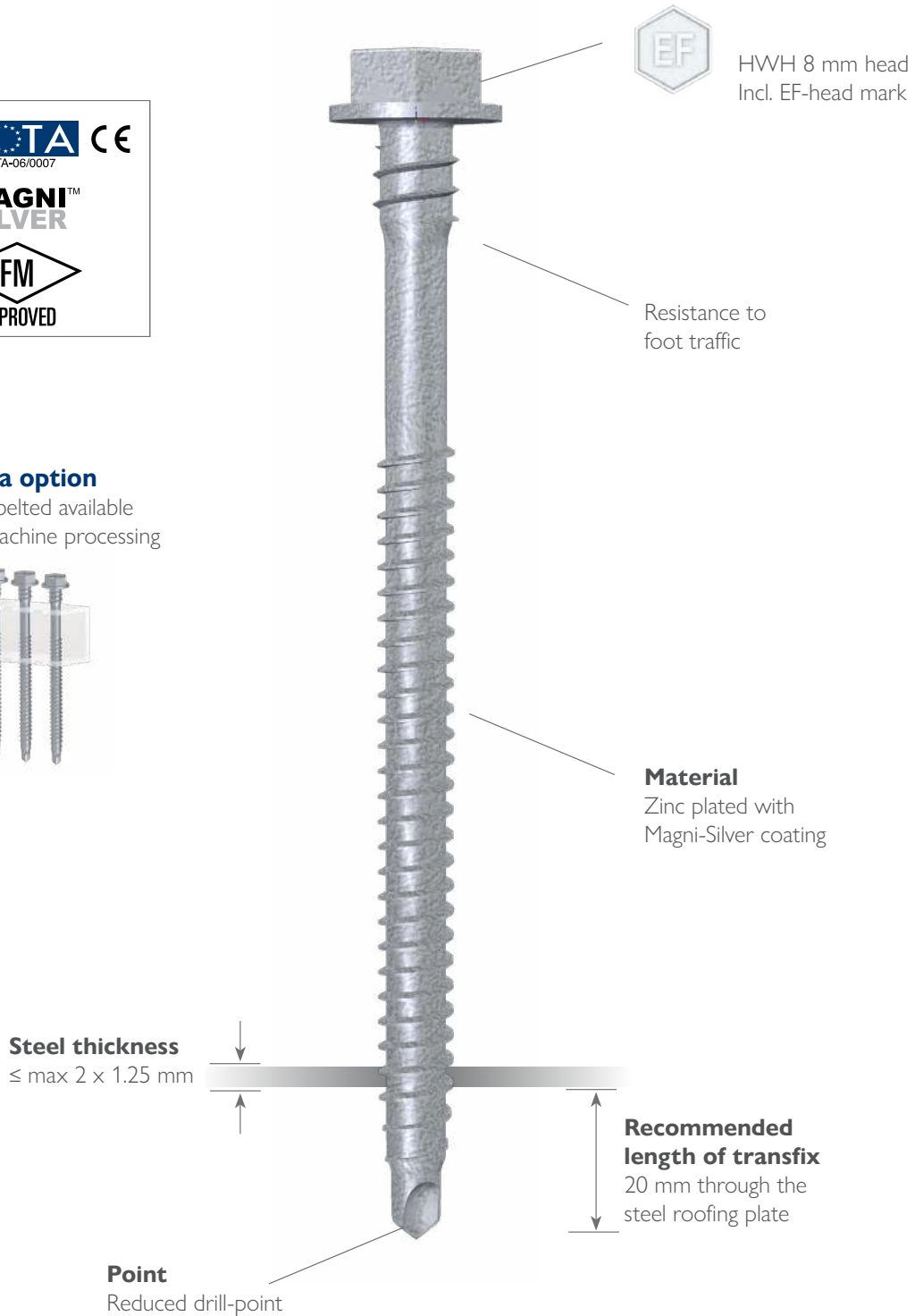

## Steel substrates ≤ max 2 x 1.25 mm

Product key	Dimensions			
	Ø	Screw	Thread	☒
EDS-BZT48060	4.8	60	50	500
EDS-BZT48070	4.8	70	50	500
EDS-BZT48080	4.8	80	50	500
EDS-BZT48090	4.8	90	50	500
EDS-BZT48100	4.8	100	50	500
EDS-BZT48120	4.8	120	75	500
EDS-BZT48140	4.8	140	75	500
EDS-BZT48160	4.8	160	105	500
EDS-BZT48180	4.8	180	120	500
EDS-BZT48200	4.8	200	120	500
EDS-BZT48220	4.8	220	120	500
EDS-BZT48240	4.8	240	120	500
EDS-BZT48260	4.8	260	120	500
EDS-BZT48280	4.8	280	120	500
EDS-BZT48300	4.8	300	120	500

### Machine processing

Eurofast® DEK-FIX



### Machine processing

EDS-BGT48060	4.8	60	50	1200
EDS-BGT48070	4.8	70	50	1200
EDS-BGT48080	4.8	80	50	1200
EDS-BGT48090	4.8	90	50	1200
EDS-BGT48100	4.8	100	50	1050
EDS-BGT48120	4.8	120	75	1050
EDS-BGT48140	4.8	140	75	750
EDS-BGT48160	4.8	160	105	750
EDS-BGT48180	4.8	180	120	750
EDS-BGT48200	4.8	200	120	750
EDS-BGT48220	4.8	220	120	750
EDS-BGT48240	4.8	240	120	750

Steel substrates  $\leq$  max 2 x 1.25 mm

# EUROFAST® EFHD

15 cycles KESTERNICH



Torx 25 drive  
Incl. EF-head mark

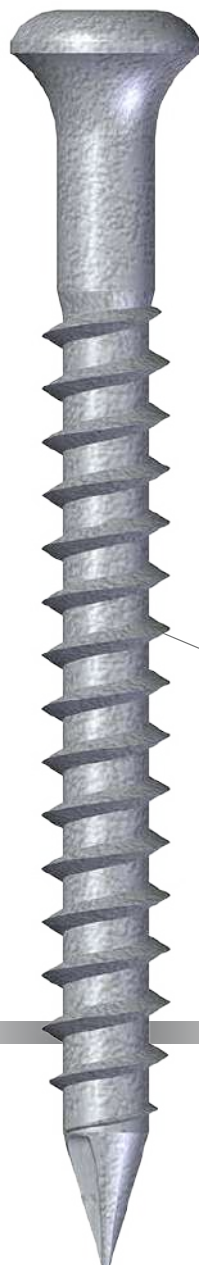

**Material**  
Zinc plated with  
Magni-Silver coating

**Steel thickness**  
 $\leq$  max 2 x 1.25 mm

**Recommended  
length of transfix**  
20 mm through the  
steel roofing plate

**Point**  
Ricoh-point

## Steel substrates $\leq$ max 2 x 1.25 mm

Product key	Dimensions			
	Ø	Screw	Thread	☒
EFHD-63030	6.3	30	25	1000
EFHD-63045	6.3	45	40	1000
EFHD-63060	6.3	60	55	500
EFHD-63070	6.3	70	60	500
EFHD-63080	6.3	80	60	500
EFHD-63100	6.3	100	70	500
EFHD-63130	6.3	130	70	500
EFHD-63160	6.3	160	70	500
EFHD-63180	6.3	180	70	500
EFHD-63200	6.3	200	70	500
EFHD-63230	6.3	230	70	500
EFHD-63250	6.3	250	70	500
EFHD-63275	6.3	275	70	500
EFHD-63300	6.3	300	70	500
EFHD-63330	6.3	330	70	500
EFHD-63350	6.3	350	70	500
EFHD-63400	6.3	400	70	250

Steel substrates > 1.00 - max 2 x 1.50 mm

# EUROFAST® EDS-BZTHD

15 cycles KESTERNICH



### Extra option

Also belted available  
for machine processing

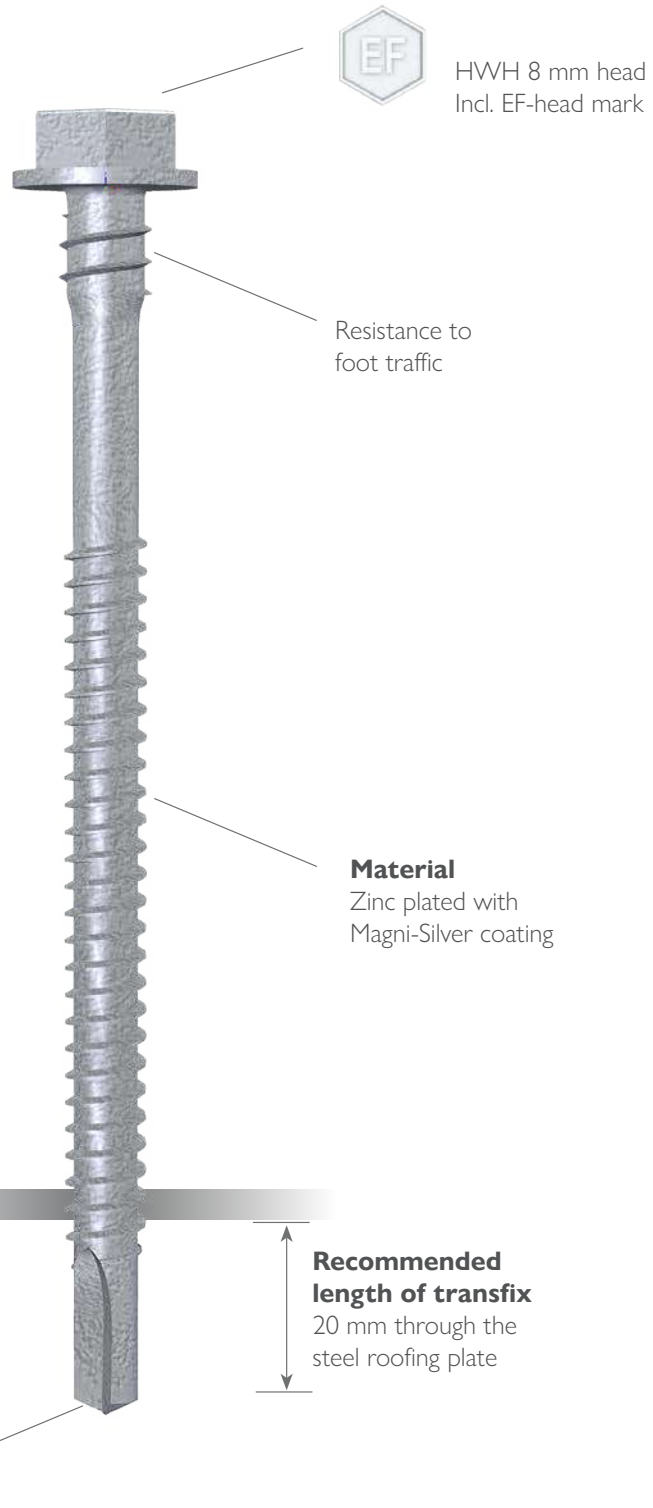



## Steel substrates > 1.00 - max 2 x 1.50 mm

Product key	Dimensions			☒
	Ø	Screw	Thread	
EDS-BZTHD48140	4.8	140	105	500
EDS-BZTHD48180	4.8	180	120	500
EDS-BZTHD48220	4.8	220	120	500
EDS-BZTHD48260	4.8	260	120	500
EDS-BZTHD48300	4.8	300	120	500

### Machine processing

Eurofast® DEK-FIX



### Machine processing

EDS-BGTHD48140	4.8	140	105	750
EDS-BGTHD48180	4.8	180	120	750
EDS-BGTHD48220	4.8	220	120	750

Steel substrates > 0.70 ≤ 0.88 mm

# EUROFAST® Combi CP-PP

15 cycles KESTERNICH

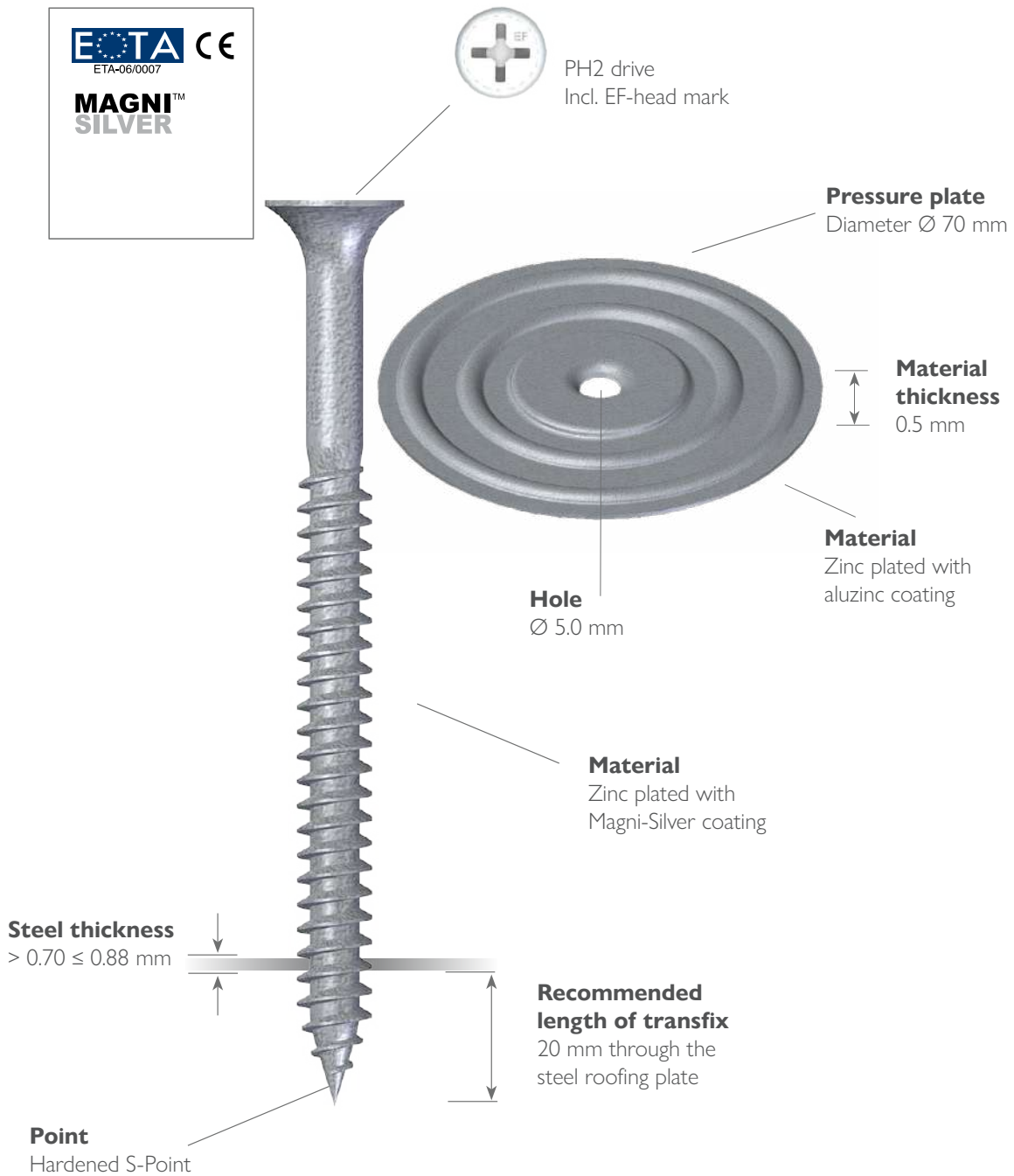

## Steel substrates > 0.70 ≤ 0.88 mm

Product key	Dimensions			☒
	Ø	Screw	Thread	
CP-PP-48050	4.8	50	45	250
CP-PP-48060	4.8	60	50	250
CP-PP-48070	4.8	70	60	250
CP-PP-48080	4.8	80	70	250
CP-PP-48090	4.8	90	80	250
CP-PP-48100	4.8	100	80	250
CP-PP-48110	4.8	110	80	250
CP-PP-48120	4.8	120	80	250
CP-PP-48130	4.8	130	80	250
CP-PP-48140	4.8	140	80	250
CP-PP-48150	4.8	150	80	250
CP-PP-48160	4.8	160	80	250
CP-PP-48170	4.8	170	80	250
CP-PP-48180	4.8	180	80	250
CP-PP-48200	4.8	200	80	250
CP-PP-48220	4.8	220	80	250

Steel substrates  $\leq$  max 2 x 1.25 mm

# EUROFAST® EDS-B-5.5

30 CYCLES KESTERNICH



Torx 25 drive  
Incl. EF-head mark

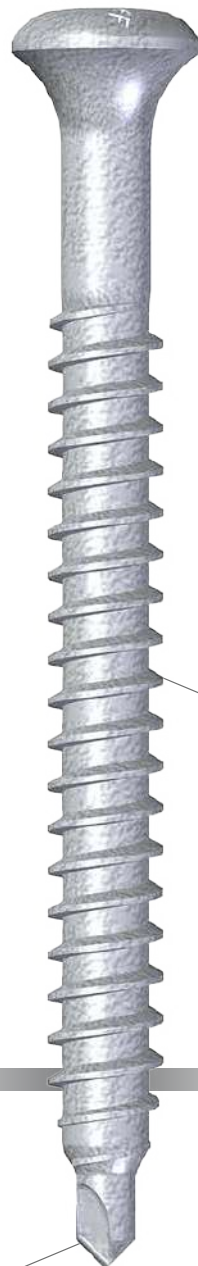

**Material**  
Zinc plated with  
Magni-Silver coating

**Steel thickness**  
 $\leq$  max 2 x 1.25 mm

**Point**  
Reduced drill-point

**Recommended  
length of transfix**  
20 mm through the  
steel roofing plate

## Steel substrates $\leq$ max 2 x 1.25 mm

Product key	Dimensions			☒
	Ø	Screw	Thread	
EDS-B-55050	5.5	50	45	1000
EDS-B-55060	5.5	60	55	1000
EDS-B-55070	5.5	70	65	1000
EDS-B-55080	5.5	80	75	1000
EDS-B-55090	5.5	90	80	1000
EDS-B-55100	5.5	100	80	500
EDS-B-55120	5.5	120	80	500
EDS-B-55140	5.5	140	80	500
EDS-B-55160	5.5	160	80	500
EDS-B-55180	5.5	180	80	500
EDS-B-55210	5.5	210	80	500

Steel substrates  $\leq$  max 2 x 1.25 mm

# OMG RS - DFDS-5.5

30 CYCLES KESTERNICH

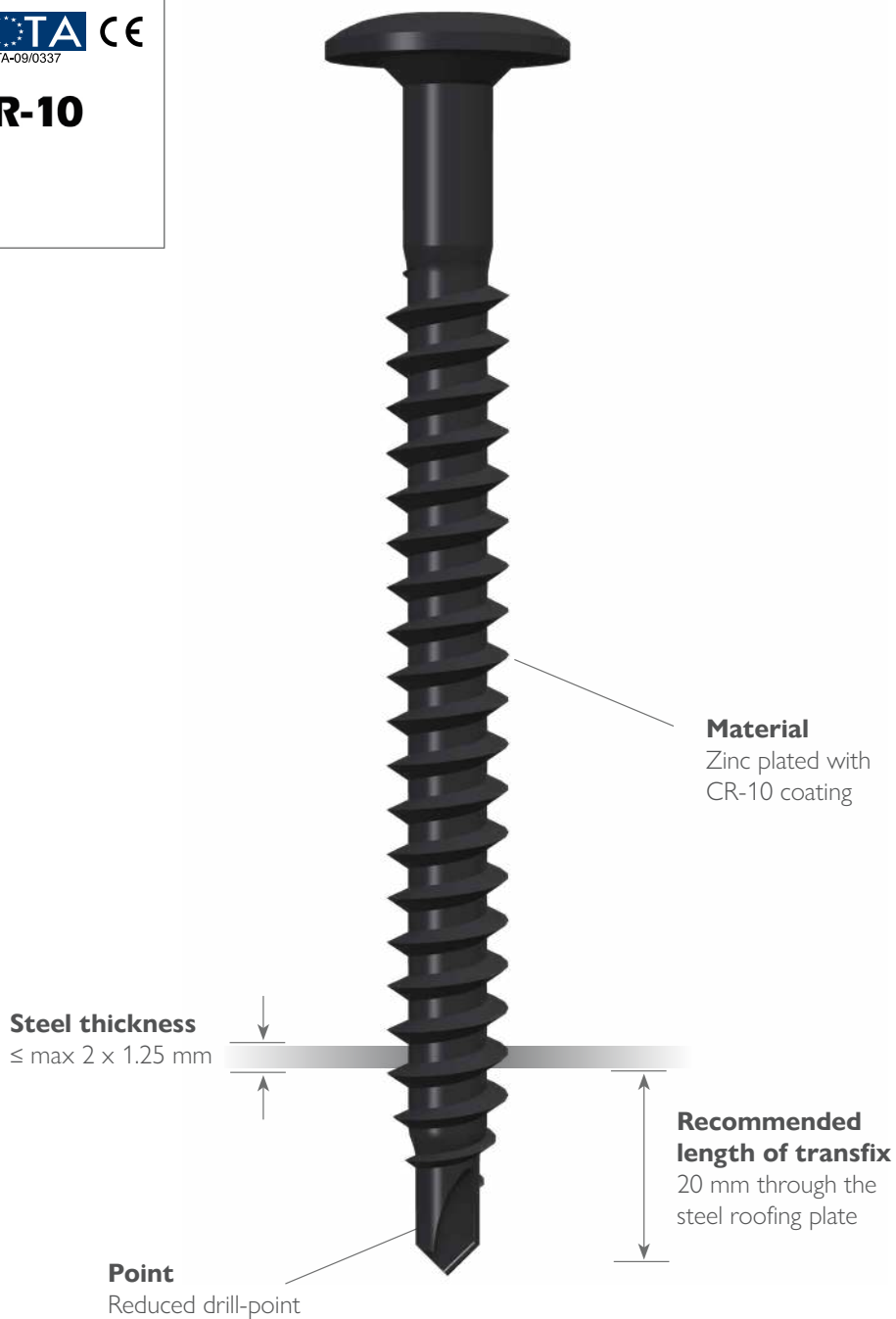

## Steel substrates $\leq$ max 2 x 1.25 mm

Product key	Dimensions			☒
	Ø	Screw	Thread	
DFDS-55040	5.5	40	40	1000
DFDS-55055	5.5	55	55	1000
DFDS-55075	5.5	75	75	1000
DFDS-55095	5.5	100	75	1000
DFDS-55125	5.5	125	75	1000
DFDS-55150	5.5	150	100	1000
DFDS-55175	5.5	175	100	1000
DFDS-55200	5.5	200	100	1000

Steel substrates  $\leq$  max 2 x 1.25 mm

## EUROFAST® DFHD

30 CYCLES KESTERNICH

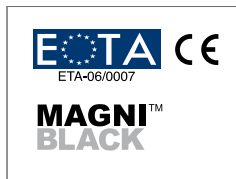

**Steel thickness**  
0.70 - 0.88 mm  
**Aluminium**  
 $\geq$  0.63 mm

**Point**  
Reduced drill-point

**Coating**  
Magni-Black



PH3 drive

**Transfix length recommended**  
20 mm through the steel roofing plate

## OMG XHD - DFHD

30 CYCLES KESTERNICH



**Steel thickness**  
 $\leq$  max 2 x 1.25 mm

**Point**  
Reduced drill-point

**Coating**  
CR-10



PH3 drive

**Recommended length of transfix**  
20 mm through the steel roofing plate



## Steel substrates ≤ max 2 x 1.25 mm

Product key	Dimensions			
	Ø	Screw	Thread	⊠
DFHD-67032	6.7	32	32	1000

Product key	Dimensions			
	Ø	Screw	Thread	⊠
DFHD-67050	6.7	50	50	1000
DFHD-67075	6.7	75	75	1000
DFHD-67100	6.7	100	75	1000
DFHD-67125	6.7	125	100	500
DFHD-67150	6.7	150	100	500
DFHD-67175	6.7	175	100	500
DFHD-67200	6.7	200	100	500
DFHD-67225	6.7	230	100	500
DFHD-67250	6.7	255	100	500
DFHD-67275	6.7	280	100	500
DFHD-67300	6.7	305	100	500
DFHD-67350	6.7	355	100	250
DFHD-67410	6.7	405	100	250
DFHD-67460	6.7	455	100	250
DFHD-67510	6.7	510	100	250
DFHD-67560	6.7	560	100	125

Steel substrates  $\leq$  max 2 x 1.25 mm

# EUROFAST® EDS-SRB

BI-METAL (STAINLESS STEEL A4)



Torx 25 drive  
Incl. EF-head mark

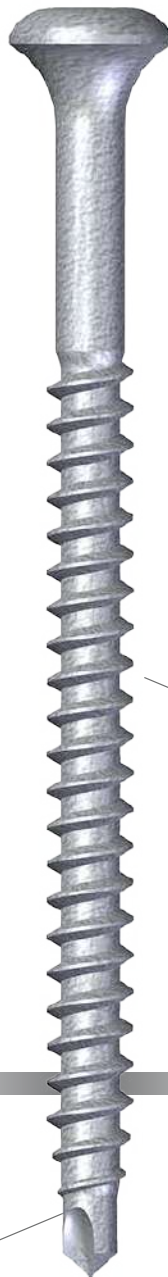

**Material**  
Bi-Metal (Stainless Steel A4)

**Steel thickness**  
 $\leq$  max 2 x 1.25 mm

**Point**  
Reduced drill-point

**Recommended length of transfix**  
20 mm through the steel roofing plate

## Steel substrates $\leq$ max 2 x 1.25 mm

Product key	Dimensions			
	Ø	Screw	Thread	⊠
EDS-SRB48060	4.8	60	50	500
EDS-SRB48080	4.8	80	50	500
EDS-SRB48100	4.8	100	50	500
EDS-SRB48120	4.8	120	75	500
EDS-SRB48140	4.8	140	75	500
EDS-SRB48160	4.8	160	120	500
EDS-SRB48180	4.8	180	120	500
EDS-SRB48210	4.8	210	120	500
EDS-SRB48240	4.8	240	120	500

Steel substrates  $\leq$  max 2 x 1.25 mm

# EUROFAST® EDS-BZTR

**BI-METAL (STAINLESS STEEL A4)**



### Extra option

Also belted available  
for machine processing

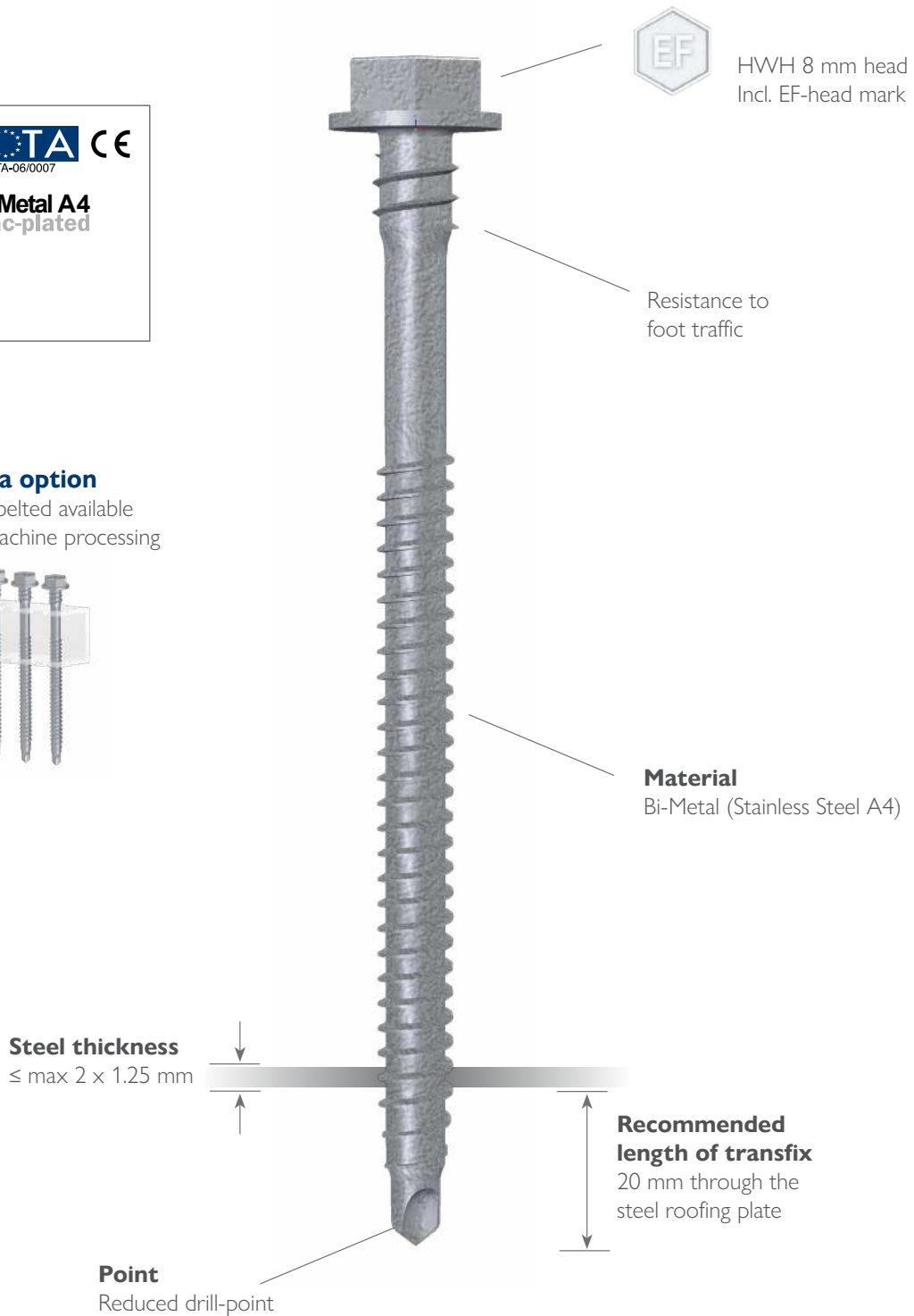

## Steel substrates ≤ max 2 x 1.25 mm

Product key	Dimensions			
	Ø	Screw	Thread	☒
EDS-BZTR48140	4.8	140	75	500
EDS-BZTR48160	4.8	160	105	500
EDS-BZTR48180	4.8	180	120	500
EDS-BZTR48200	4.8	200	120	500
EDS-BZTR48220	4.8	220	120	500
EDS-BZTR48240	4.8	240	120	500

### Machine processing

Eurofast® DEK-FIX



### Machine processing

* EDS-BGTR48140	4.8	140	75	750
* EDS-BGTR48160	4.8	160	105	750
* EDS-BGTR48180	4.8	180	120	750
* EDS-BZTR48200	4.8	200	120	750
* EDS-BGTR48220	4.8	220	120	750
* EDS-BGTR48240	4.8	240	120	750

\* Delivery-time on request

Tube washer combination for steel substrates  $> 0.70 \leq 0.88$  mm

# EUROFAST® TRPS-45

15 CYCLES KESTERNICH



PH2 drive  
Incl. EF-head mark



### Extra option

Also belted available  
for machine processing

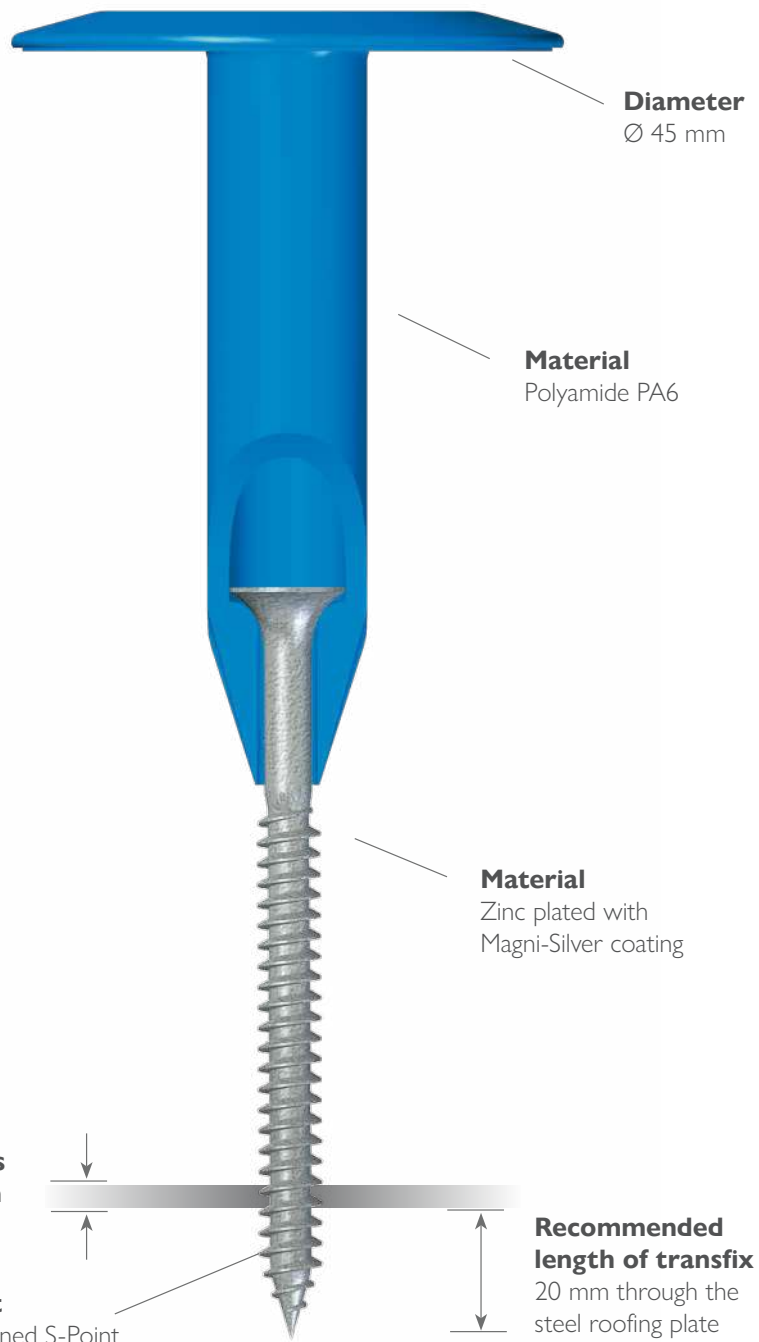

## Tube washer combination for steel substrates > 0.70 ≤ 0.88 mm

Product key	Clamping	Dimensions			☒
	mm	Tube	Screw		
TRPS-45-040	35 - 44	30	50	250	
TRPS-45-050	45 - 54	30	60	250	
TRPS-45-060	55 - 64	30	70	250	
TRPS-45-070	65 - 74	30	80	250	
TRPS-45-080	75 - 84	60	60	250	
TRPS-45-090	85 - 94	60	70	250	
TRPS-45-100	95 - 104	60	80	250	
TRPS-45-110	105 - 114	60	90	250	
TRPS-45-120	115 - 124	90	70	250	
TRPS-45-130	125 - 134	90	80	250	
TRPS-45-140	135 - 144	90	90	250	
TRPS-45-150	145 - 154	120	70	250	
TRPS-45-160	155 - 164	120	80	250	
TRPS-45-170	165 - 174	120	90	250	
TRPS-45-180	175 - 184	150	70	250	
TRPS-45-190	185 - 194	150	80	250	
* TRPS-45-200	195 - 204	150	90	250	
* TRPS-45-210	205 - 214	150	100	250	
* TRPS-45-220	215 - 224	150	110	250	

\* Delivery-time on request

### Machine processing

Eurofast® EURO-FIX



Machine processing					
Product key	Clamping	Dimensions			☒
	mm	Tube	Screw		
* TRPSG-45-040	35 - 44	30	50	1000	
* TRPSG-45-050	45 - 54	30	60	1000	
* TRPSG-45-060	55 - 64	30	70	1000	
* TRPSG-45-070	65 - 74	30	80	1000	
* TRPSG-45-080	75 - 84	60	60	1000	
* TRPSG-45-090	85 - 94	60	70	1000	
* TRPSG-45-100	95 - 104	60	80	1000	
* TRPSG-45-110	105 - 114	60	90	1000	
* TRPSG-45-120	115 - 124	90	70	1000	
* TRPSG-45-130	125 - 134	90	80	1000	
* TRPSG-45-140	135 - 144	90	90	1000	
* TRPSG-45-150	145 - 154	120	70	1000	

\* Delivery-time on request

Product key	Clamping	Dimensions			☒
	mm	Tube	Screw		
* TRPS-45-230	225 - 234	150	120	250	
* TRPS-45-240	235 - 244	150	130	250	
* TRPS-45-250	241 - 250	225	60	250	
* TRPS-45-260	251 - 260	225	70	250	
* TRPS-45-270	261 - 270	225	80	250	
* TRPS-45-280	271 - 280	225	90	250	
* TRPS-45-290	281 - 290	225	100	250	
* TRPS-45-300	291 - 300	225	110	250	
* TRPS-45-310	301 - 310	285	60	250	
* TRPS-45-320	311 - 320	285	70	250	
* TRPS-45-330	321 - 330	285	80	250	
* TRPS-45-340	331 - 340	285	90	250	
* TRPS-45-350	341 - 350	285	100	250	
* TRPS-45-360	351 - 360	285	110	250	
* TRPS-45-370	361 - 370	285	120	250	
* TRPS-45-380	371 - 380	285	130	250	
* TRPS-45-390	381 - 390	285	140	250	
* TRPS-45-400	391 - 400	285	150	250	
* TRPS-45-410	401 - 410	285	160	250	

### Upright processing

Eurofast® EASYTOOL-PRO



Machine processing					
Product key	Clamping	Dimensions			☒
	mm	Tube	Screw		
* TRPSG-45-160	155 - 164	120	80	1000	
* TRPSG-45-170	165 - 174	120	90	750	
* TRPSG-45-180	175 - 184	150	70	750	
* TRPSG-45-190	185 - 194	150	80	750	
* TRPSG-45-200	195 - 204	150	90	750	
* TRPSG-45-210	205 - 214	150	100	750	
* TRPSG-45-220	215 - 224	150	110	750	
* TRPSG-45-230	225 - 234	150	120	750	
* TRPSG-45-240	235 - 244	150	130	600	
* TRPSG-45-250	245 - 254	150	140	600	
* TRPSG-45-260	255 - 264	150	150	600	

Tube washer combination for steel substrates  $> 0.70 \leq 0.88$  mm

# EUROFAST® BTRPS-45

15 CYCLES KESTERNICH



PH2 drive  
Incl. EF-head mark

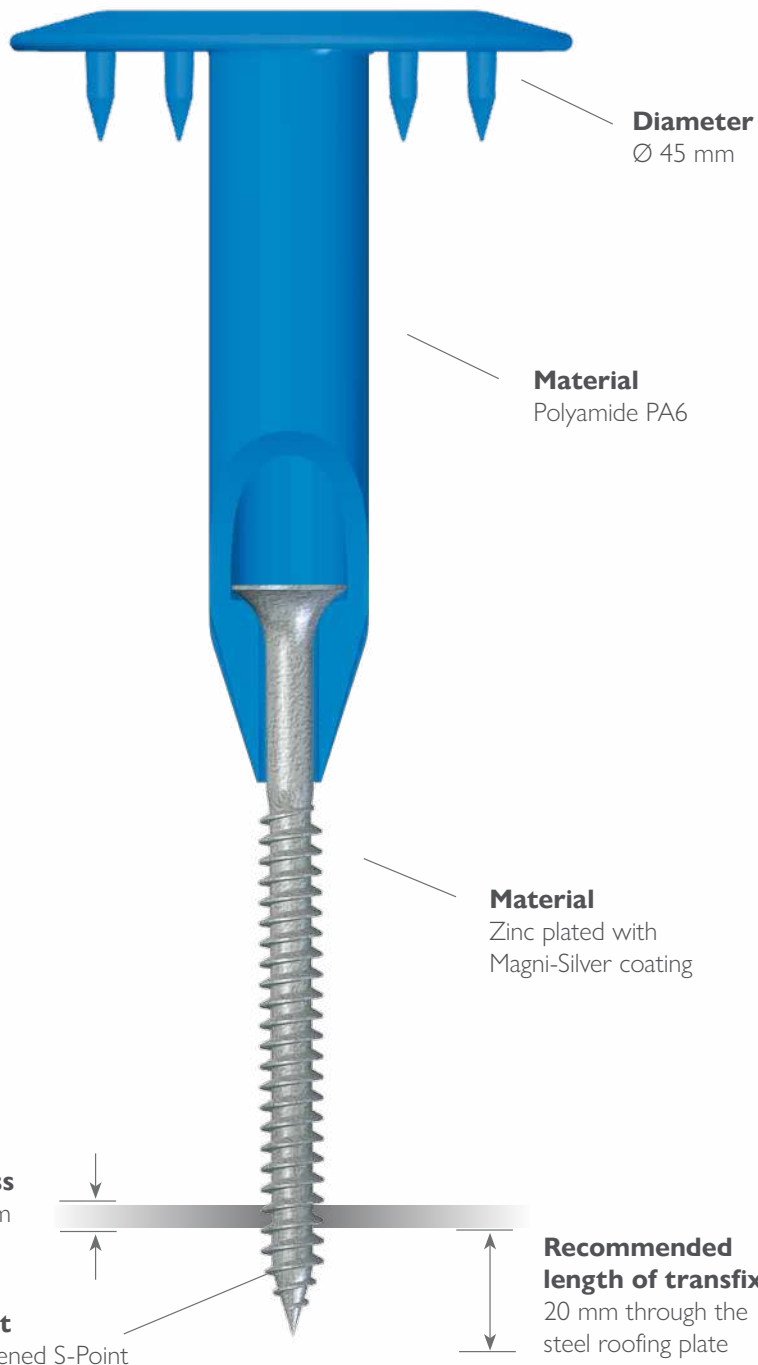



## Tube washer combination for steel substrates $> 0.70 \leq 0.88$ mm

Product key	Clamping	Dimensions			✉
	mm	Tube	Screw		
BTRPS-45-040	35 - 44	30	50	250	
BTRPS-45-050	45 - 54	30	60	250	
BTRPS-45-060	55 - 64	30	70	250	
BTRPS-45-070	65 - 74	30	80	250	
BTRPS-45-080	75 - 84	60	60	250	
BTRPS-45-090	85 - 94	60	70	250	
BTRPS-45-100	95 - 104	60	80	250	
BTRPS-45-110	105 - 114	60	90	250	
BTRPS-45-120	115 - 124	90	70	250	
BTRPS-45-130	125 - 134	90	80	250	
BTRPS-45-140	135 - 144	90	90	250	

Product key	Clamping	Dimensions			✉
	mm	Tube	Screw		
BTRPS-45-150	145 - 154	120	70	250	
BTRPS-45-160	155 - 164	120	80	250	
BTRPS-45-170	165 - 174	120	90	250	
BTRPS-45-180	175 - 184	150	70	250	
BTRPS-45-190	185 - 194	150	80	250	
* BTRPS-45-200	195 - 204	150	90	250	
* BTRPS-45-210	205 - 214	150	100	250	
* BTRPS-45-220	215 - 224	150	110	250	
* BTRPS-45-230	225 - 234	150	120	250	
* BTRPS-45-240	235 - 244	150	130	250	

\* Delivery-time on request

### Upright processing

Eurofast® EASYTOOL-PRO



Tube washer combination for steel substrates  $> 0.70 \leq 0.88$  mm

# EUROFAST® TWPS-8040

15 CYCLES KESTERNICH



PH2 drive  
Incl. EF-head mark



### Extra option

Also belted available  
for machine processing

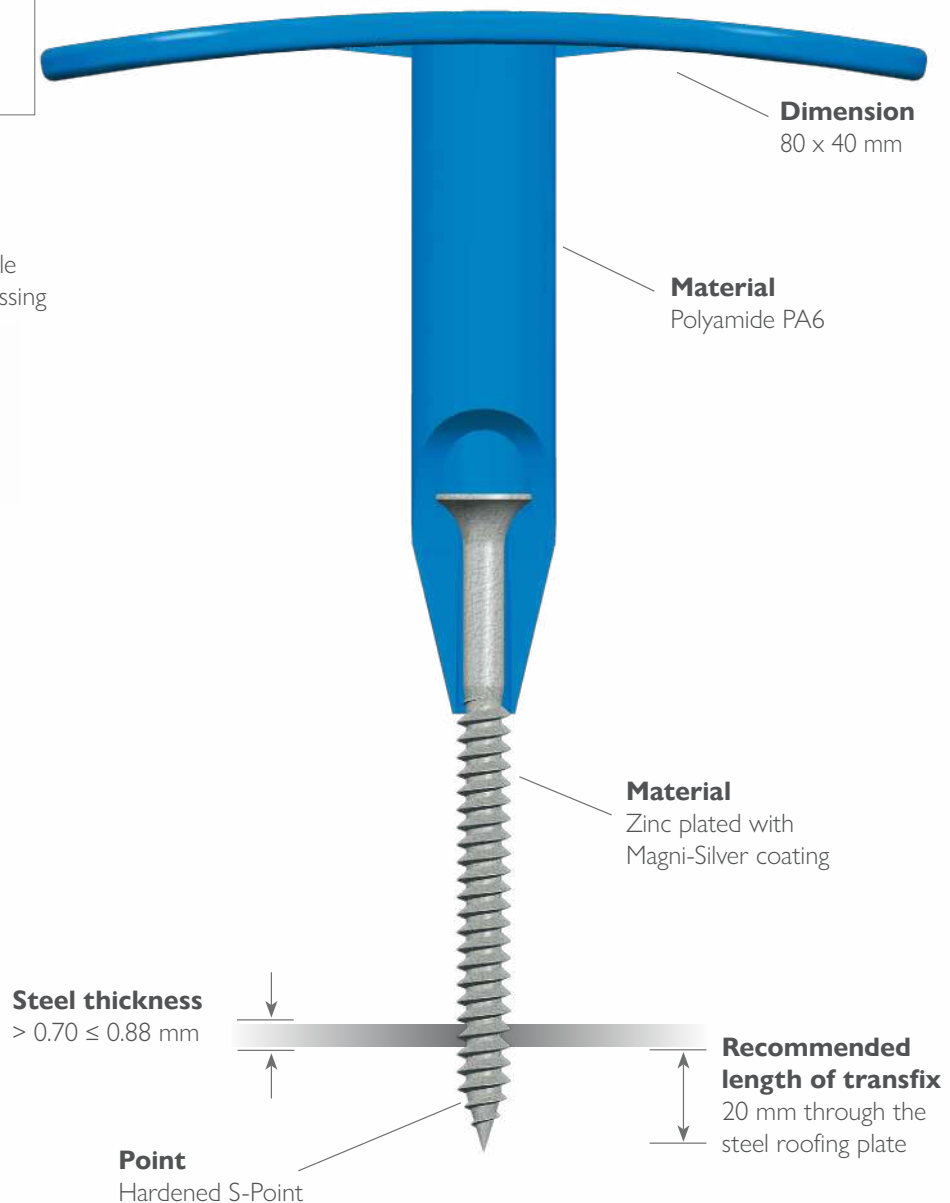

## Tube washer combination for steel substrates > 0.70 ≤ 0.88 mm

Product key	Clamping	Dimensions			☒
	mm	Tube	Screw		
* TWPS-8040-040	31 - 44	30	50	250	
* TWPS-8040-050	45 - 54	30	60	250	
* TWPS-8040-060	55 - 64	30	70	250	
* TWPS-8040-070	65 - 74	30	80	250	
* TWPS-8040-080	75 - 84	60	60	250	
* TWPS-8040-090	85 - 94	60	70	250	
* TWPS-8040-100	95 - 104	60	80	250	
* TWPS-8040-110	105 - 114	60	90	250	
* TWPS-8040-120	115 - 124	90	70	250	
* TWPS-8040-130	125 - 134	90	80	250	
* TWPS-8040-140	135 - 144	90	90	250	
* TWPS-8040-150	145 - 154	120	70	250	
* TWPS-8040-160	155 - 164	120	80	250	
* TWPS-8040-170	165 - 174	120	90	250	
* TWPS-8040-180	175 - 184	150	70	250	
* TWPS-8040-190	185 - 194	150	80	250	

Product key	Clamping	Dimensions			☒
	mm	Tube	Screw		
* TWPS-8040-200	195 - 204	150	90	250	
* TWPS-8040-210	205 - 214	150	100	250	
* TWPS-8040-220	215 - 224	150	110	250	
* TWPS-8040-230	225 - 234	150	120	250	
* TWPS-8040-240	235 - 244	150	130	250	
* TWPS-8040-250	245 - 254	150	140	250	
* TWPS-8040-260	255 - 264	150	150	250	
* TWPS-8040-270	265 - 274	150	160	250	
* TWPS-8040-280	275 - 284	150	170	250	
* TWPS-8040-290	285 - 294	150	180	250	
* TWPS-8040-310	295 - 314	150	200	250	
* TWPS-8040-330	315 - 334	150	220	250	
* TWPS-8040-350	335 - 354	150	240	250	
* TWPS-8040-370	355 - 374	150	260	250	
* TWPS-8040-390	375 - 394	150	280	250	
* TWPS-8040-410	395 - 414	150	300	250	

\* Delivery-time on request

### Machine processing Eurofast® EURO-FIX



### Upright processing Eurofast® EASYTOOL-PRO



Machine processing					
Product key	Clamping	Dimensions			☒
	mm	Tube	Screw		
* TWPSG-8040-040	31 - 44	30	50	750	
* TWPSG-8040-050	45 - 54	30	60	750	
* TWPSG-8040-060	55 - 64	30	70	750	
* TWPSG-8040-070	65 - 74	30	80	750	
* TWPSG-8040-080	75 - 84	60	60	750	
* TWPSG-8040-090	85 - 94	60	70	750	
* TWPSG-8040-100	95 - 104	60	80	750	
* TWPSG-8040-110	105 - 114	60	90	750	
* TWPSG-8040-120	115 - 124	90	70	750	
* TWPSG-8040-130	125 - 134	90	80	750	
* TWPSG-8040-140	135 - 144	90	90	750	
* TWPSG-8040-150	145 - 154	120	70	750	

Machine processing					
Product key	Clamping	Dimensions			☒
	mm	Tube	Screw		
* TWPSG-8040-160	155 - 164	120	80	750	
* TWPSG-8040-170	165 - 174	120	90	600	
* TWPSG-8040-180	175 - 184	150	70	600	
* TWPSG-8040-190	185 - 194	150	80	600	
* TWPSG-8040-200	195 - 204	150	90	600	
* TWPSG-8040-210	205 - 214	150	100	600	
* TWPSG-8040-220	215 - 224	150	110	600	
* TWPSG-8040-230	225 - 234	150	120	600	
* TWPSG-8040-240	235 - 244	150	130	450	
* TWPSG-8040-250	245 - 254	150	140	450	
* TWPSG-8040-260	255 - 264	150	150	450	

\* Delivery-time on request

Tube washer combination for steel substrates  $> 0.70 \leq 0.88$  mm

# EUROFAST® TLKS-45

15 CYCLES KESTERNICH



PH2 drive  
Incl. EF-head mark

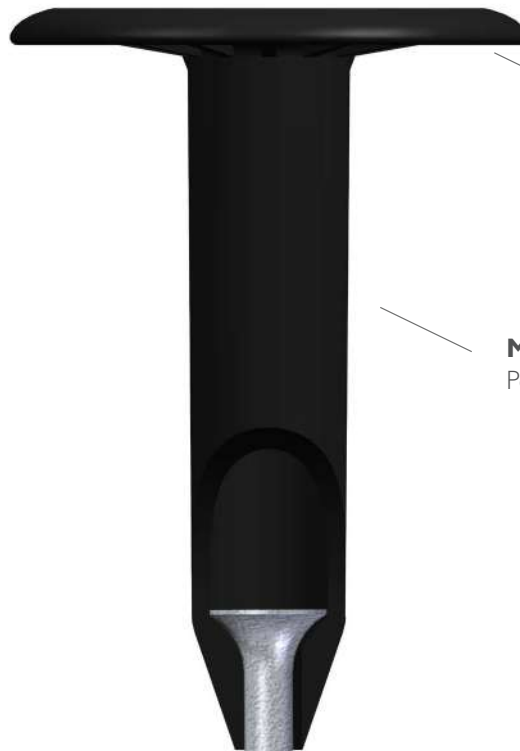
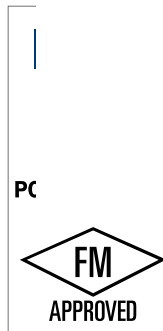

**Diameter**  
Ø 45 mm

**Material**  
Polypropylene (PP)

**Material**  
Zinc plated with  
Magni-Silver coating

**Steel thickness**  
 $> 0.70 \leq 0.88$  mm

**Point**  
Hardened S-Point

**Recommended  
length of transfix**  
20 mm through the  
steel roofing plate

## Tube washer combination for steel substrates > 0.70 ≤ 0.88 mm

Product key	Clamping	Dimensions			✉
	mm	Tube	Screw		
* TLKS-45-050	45 - 54	35	60	250	
* TLKS-45-060	55 - 64	35	70	250	
* TLKS-45-070	65 - 74	35	80	250	
* TLKS-45-080	75 - 84	35	90	250	
* TLKS-45-090	85 - 94	65	70	250	
* TLKS-45-100	95 - 104	65	80	250	
* TLKS-45-110	105 - 114	85	70	250	
* TLKS-45-120	115 - 124	85	80	250	
* TLKS-45-130	125 - 134	105	70	250	
TLKS-45-140	135 - 144	105	80	250	
TLKS-45-150	145 - 154	105	90	250	
TLKS-45-160	155 - 164	135	70	250	
* TLKS-45-170	165 - 174	135	80	250	
* TLKS-45-180	175 - 184	135	90	250	
* TLKS-45-190	185 - 194	165	70	250	
TLKS-45-200	195 - 204	165	80	250	
* TLKS-45-210	205 - 214	185	70	250	
* TLKS-45-220	215 - 224	185	80	250	
* TLKS-45-230	225 - 234	185	90	250	
* TLKS-45-240	235 - 244	185	100	250	
* TLKS-45-250	245 - 254	225	70	125	
* TLKS-45-260	255 - 264	225	80	125	
* TLKS-45-270	265 - 274	225	90	125	
* TLKS-45-280	275 - 284	255	70	125	
* TLKS-45-290	285 - 294	255	80	125	
* TLKS-45-300	295 - 304	255	90	125	
* TLKS-45-320	305 - 324	285	80	125	
* TLKS-45-340	325 - 344	285	100	125	
* TLKS-45-360	345 - 364	320	90	125	
* TLKS-45-380	365 - 384	320	110	125	
* TLKS-45-400	385 - 404	320	130	125	
* TLKS-45-420	405 - 424	320	150	125	
* TLKS-45-440	425 - 444	320	170	125	
* TLKS-45-450	445 - 454	320	180	125	
* TLKS-45-470	455 - 474	320	200	125	
* TLKS-45-490	475 - 494	320	220	125	
* TLKS-45-510	495 - 514	320	240	125	
* TLKS-45-530	515 - 534	320	260	125	
* TLKS-45-550	535 - 554	320	280	125	
* TLKS-45-570	555 - 574	320	300	125	

\* Delivery-time on request

### Upright processing

Eurofast® EASYTOOL-PRO



Tube washer combination for steel substrates  $> 0.70 \leq 0.88$  mm

# EUROFAST® TLKS-75

15 CYCLES KESTERNICH



PH2 drive  
Incl. EF-head mark

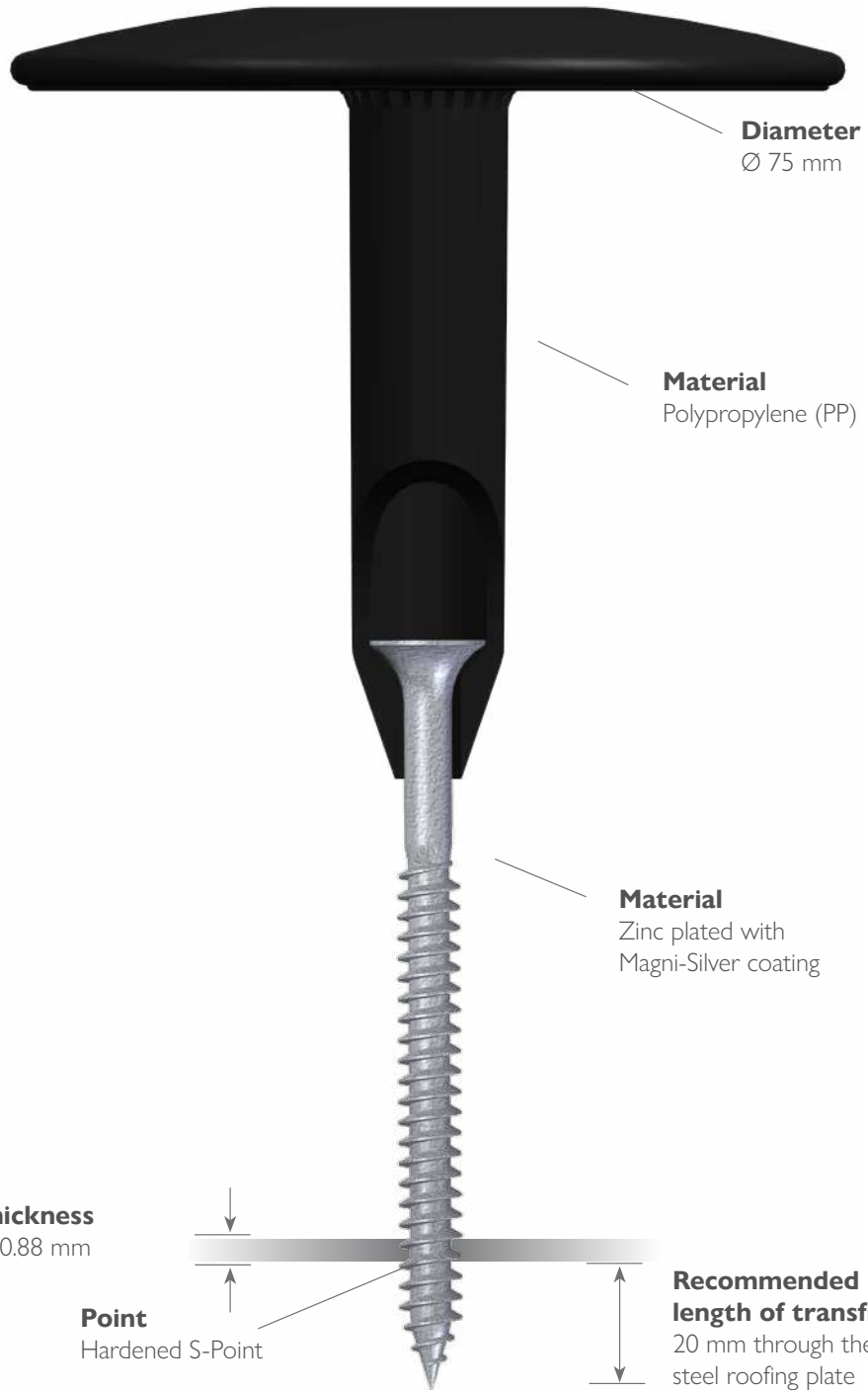

## Tube washer combination for steel substrates $> 0.70 \leq 0.88$ mm

Product key	Clamping	Dimensions			☒
	mm	Tube	Screw		
* TLKS-75-050	45 - 54	35	60	250	
TLKS-75-060	55 - 64	35	70	250	
TLKS-75-070	65 - 74	35	80	250	
TLKS-75-080	75 - 84	35	90	250	
TLKS-75-090	85 - 94	65	70	250	
TLKS-75-100	95 - 104	65	80	250	
TLKS-75-110	105 - 114	85	70	250	
TLKS-75-120	115 - 124	85	80	250	
TLKS-75-130	125 - 134	105	70	250	
TLKS-75-140	135 - 144	105	80	250	
TLKS-75-150	145 - 154	105	90	250	
TLKS-75-160	155 - 164	135	70	125	
TLKS-75-170	165 - 174	135	80	125	
TLKS-75-180	175 - 184	135	90	125	
TLKS-75-190	185 - 194	165	70	125	
TLKS-75-200	195 - 204	165	80	125	
TLKS-75-210	205 - 214	185	70	125	

Product key	Clamping	Dimensions			☒
	mm	Tube	Screw		
TLKS-75-220	215 - 224	185	80	125	
TLKS-75-230	225 - 234	185	90	125	
TLKS-75-240	235 - 244	185	100	125	
* TLKS-75-250	245 - 254	185	110	125	
* TLKS-75-260	255 - 264	185	120	125	
* TLKS-75-270	265 - 274	185	130	125	
* TLKS-75-280	275 - 284	185	140	125	
* TLKS-75-290	285 - 294	185	150	125	
* TLKS-75-300	295 - 304	185	160	125	
* TLKS-75-310	305 - 314	185	170	125	
* TLKS-75-320	315 - 324	185	180	125	
* TLKS-75-340	325 - 344	185	200	125	
* TLKS-75-360	345 - 364	185	220	125	
* TLKS-75-380	365 - 384	185	240	125	
* TLKS-75-400	385 - 404	185	260	125	
* TLKS-75-420	405 - 424	185	280	125	
* TLKS-75-440	425 - 444	185	300	125	

\* Delivery-time on request

### Upright processing

Eurofast® EASYTOOL-PRO



Tube washer combination for steel substrates  $\leq \max 2 \times 1.25 \text{ mm}$

# EUROFAST® TRPB-45

15 CYCLES KESTERNICH



Torx 25 drive  
Incl. EF-head mark



### Extra option

Also belted available  
for machine processing

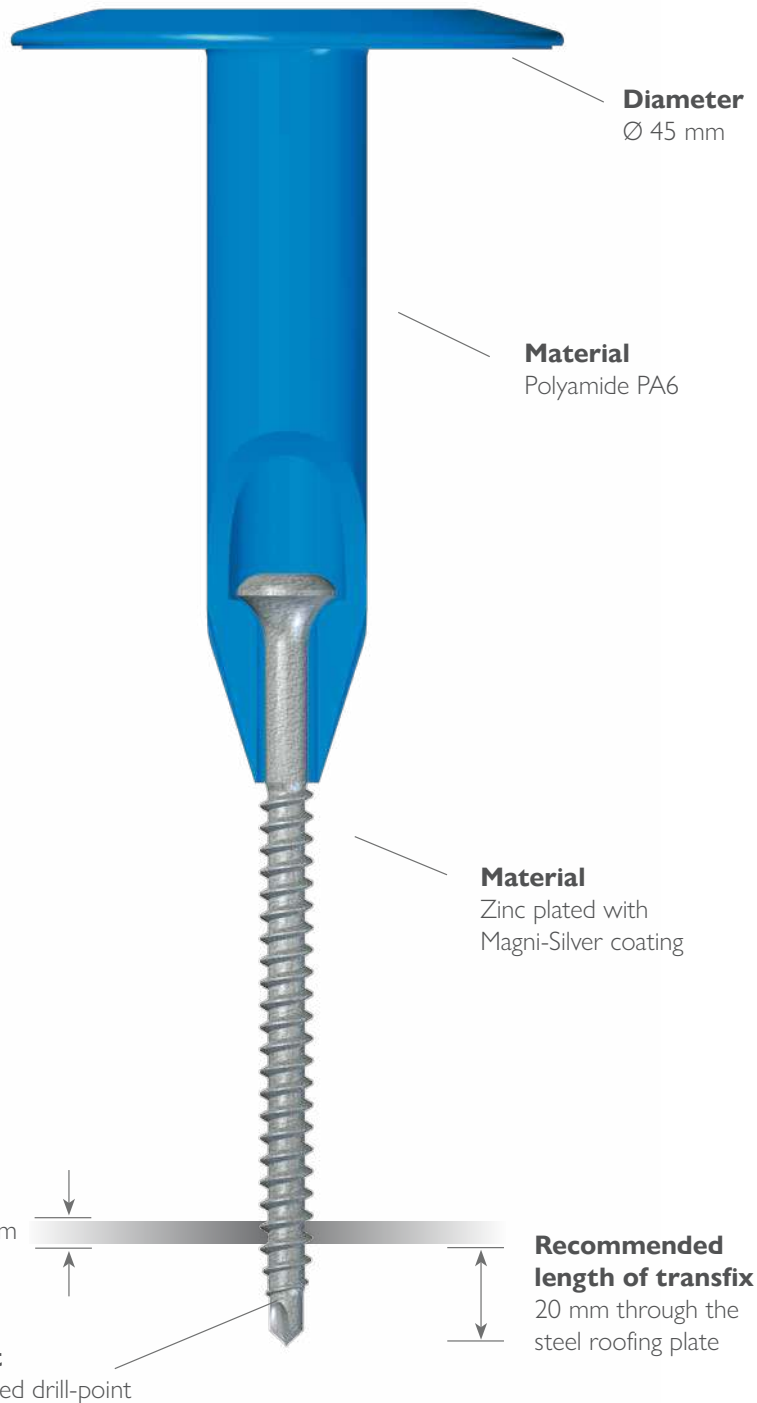



## Tube washer combination for steel substrates ≤ max 2 x 1.25 mm

Product key	Clamping	Dimensions			☒
	mm	Tube	Screw		
TRPB-45-040	35 - 44	30	50	250	
TRPB-45-050	45 - 54	30	60	250	
TRPB-45-060	55 - 64	30	70	250	
TRPB-45-070	65 - 74	30	80	250	
TRPB-45-080	75 - 84	60	60	250	
TRPB-45-090	85 - 94	60	70	250	
TRPB-45-100	95 - 104	60	80	250	
TRPB-45-110	105 - 114	60	90	250	
TRPB-45-120	115 - 124	90	70	250	
TRPB-45-130	125 - 134	90	80	250	
TRPB-45-140	135 - 144	90	90	250	
TRPB-45-150	145 - 154	120	70	250	
TRPB-45-160	155 - 164	120	80	250	
TRPB-45-170	165 - 174	120	90	250	
TRPB-45-180	175 - 184	150	70	250	
TRPB-45-190	185 - 194	150	80	250	
TRPB-45-200	195 - 204	150	90	250	
TRPB-45-210	205 - 214	150	100	250	
TRPB-45-220	215 - 224	150	110	250	

Product key	Clamping	Dimensions			☒
	mm	Tube	Screw		
TRPB-45-230	225 - 234	150	120	250	
TRPB-45-240	235 - 244	150	130	250	
TRPB-45-250	241 - 250	225	60	250	
TRPB-45-260	251 - 260	225	70	250	
TRPB-45-270	261 - 270	225	80	250	
TRPB-45-280	271 - 280	225	90	250	
TRPB-45-290	281 - 290	225	100	250	
TRPB-45-300	291 - 300	225	110	250	
TRPB-45-310	301 - 310	285	60	250	
TRPB-45-320	311 - 320	285	70	250	
TRPB-45-330	321 - 330	285	80	250	
TRPB-45-340	331 - 340	285	90	250	
TRPB-45-350	341 - 350	285	100	250	
TRPB-45-360	351 - 360	285	110	250	
TRPB-45-370	361 - 370	285	120	250	
TRPB-45-380	371 - 380	285	130	250	
TRPB-45-390	381 - 390	285	140	250	
TRPB-45-400	391 - 400	285	150	250	

### Machine processing

Eurofast® EURO-FIX



### Upright processing

Eurofast® EASYTOOL-PRO



Machine processing					
Product key	Clamping	Dimensions			☒
	mm	Tube	Screw		
TRPBG-45-040	35 - 44	30	50	1000	
TRPBG-45-050	45 - 54	30	60	1000	
TRPBG-45-060	55 - 64	30	70	1000	
TRPBG-45-070	65 - 74	30	80	1000	
TRPBG-45-080	75 - 84	60	60	1000	
TRPBG-45-090	85 - 94	60	70	1000	
TRPBG-45-100	95 - 104	60	80	1000	
TRPBG-45-110	105 - 114	60	90	1000	
TRPBG-45-120	115 - 124	90	70	1000	
TRPBG-45-130	125 - 134	90	80	1000	
TRPBG-45-140	135 - 144	90	90	1000	
TRPBG-45-150	145 - 154	120	70	1000	

Machine processing					
Product key	Clamping	Dimensions			☒
	mm	Tube	Screw		
TRPBG-45-160	155 - 164	120	80	1000	
TRPBG-45-170	165 - 174	120	90	750	
TRPBG-45-180	175 - 184	150	70	750	
TRPBG-45-190	185 - 194	150	80	750	
TRPBG-45-200	195 - 204	150	90	750	
TRPBG-45-210	205 - 214	150	100	750	
TRPBG-45-220	215 - 224	150	110	750	
TRPBG-45-230	225 - 234	150	120	750	
TRPBG-45-240	235 - 244	150	130	600	
TRPBG-45-250	245 - 254	150	140	600	
TRPBG-45-260	255 - 264	150	150	600	

Tube washer combination for steel substrates  $\leq$  max 2 x 1.25 mm

# EUROFAST® BTRPB-45

15 CYCLES KESTERNICH



Torx 25 drive  
Incl. EF-head mark

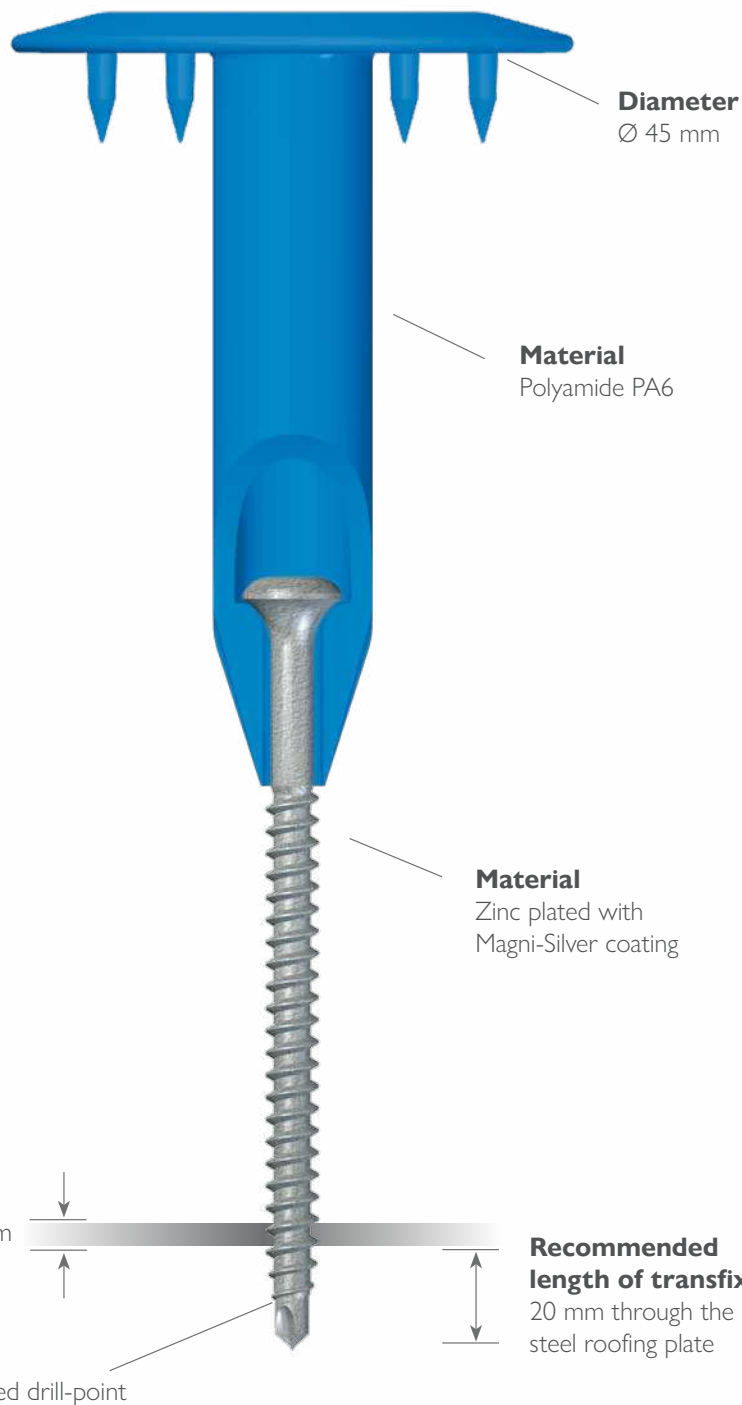

## Tube washer combination for steel substrates $\leq$ max 2 x 1.25 mm

Product key	Clamping	Dimensions		
	mm	Tube	Screw	⊠
BTRPB-45-040	35 - 44	30	50	250
BTRPB-45-050	45 - 54	30	60	250
BTRPB-45-060	55 - 64	30	70	250
BTRPB-45-070	65 - 74	30	80	250
BTRPB-45-080	75 - 84	60	60	250
BTRPB-45-090	85 - 94	60	70	250
BTRPB-45-100	95 - 104	60	80	250
BTRPB-45-110	105 - 114	60	90	250
BTRPB-45-120	115 - 124	90	70	250
BTRPB-45-130	125 - 134	90	80	250
BTRPB-45-140	135 - 144	90	90	250

Product key	Clamping	Dimensions		
	mm	Tube	Screw	⊠
BTRPB-45-150	145 - 154	120	70	250
BTRPB-45-160	155 - 164	120	80	250
BTRPB-45-170	165 - 174	120	90	250
BTRPB-45-180	175 - 184	150	70	250
BTRPB-45-190	185 - 194	150	80	250
BTRPB-45-200	195 - 204	150	90	250
BTRPB-45-210	205 - 214	150	100	250
BTRPB-45-220	215 - 224	150	110	250
BTRPB-45-230	225 - 234	150	120	250
BTRPB-45-240	235 - 244	150	130	250

### Upright processing

Eurofast® EASYTOOL-PRO



Tube washer combination for steel substrates  $\leq \max 2 \times 1.25 \text{ mm}$

# EUROFAST® TWPB-8040

15 CYCLES KESTERNICH



Torx 25 drive  
Incl. EF-head mark

### Extra option

Also belted available  
for machine processing

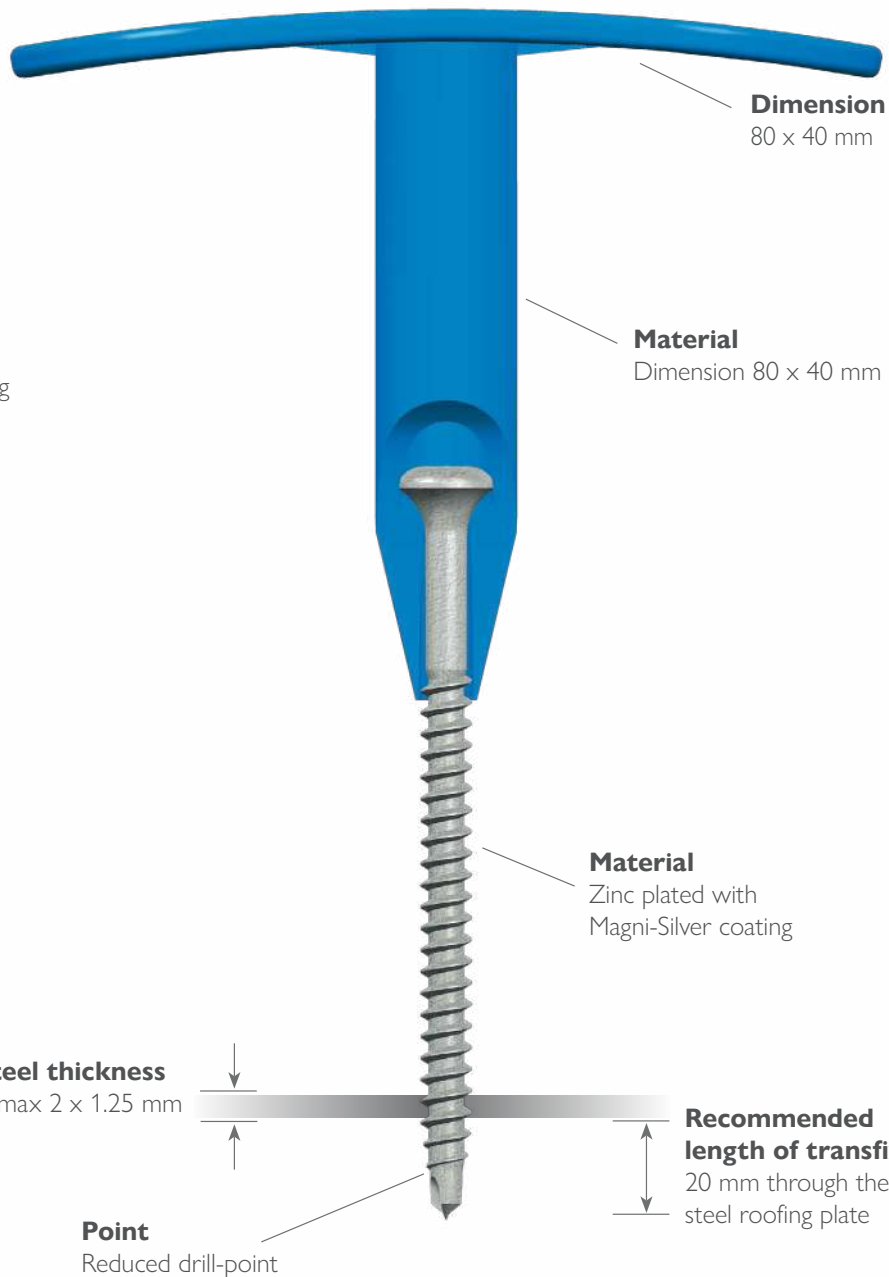

## Tube washer combination for steel substrates ≤ max 2 x 1.25 mm

Product key	Clamping	Dimensions			☒
	mm	Tube	Screw		
* TWPB-8040-040	31 - 44	30	50	250	
* TWPB-8040-050	45 - 54	30	60	250	
* TWPB-8040-060	55 - 64	30	70	250	
* TWPB-8040-070	65 - 74	30	80	250	
* TWPB-8040-080	75 - 84	60	60	250	
* TWPB-8040-090	85 - 94	60	70	250	
* TWPB-8040-100	95 - 104	60	80	250	
* TWPB-8040-110	105 - 114	60	90	250	
* TWPB-8040-120	115 - 124	90	70	250	
* TWPB-8040-130	125 - 134	90	80	250	
* TWPB-8040-140	135 - 144	90	90	250	
* TWPB-8040-150	145 - 154	120	70	250	
* TWPB-8040-160	155 - 164	120	80	250	
* TWPB-8040-170	165 - 174	120	90	250	
* TWPB-8040-180	175 - 184	150	70	250	

Product key	Clamping	Dimensions			☒
	mm	Tube	Screw		
* TWPB-8040-190	185 - 194	150	80	250	
* TWPB-8040-200	195 - 204	150	90	250	
* TWPB-8040-210	205 - 214	150	100	250	
* TWPB-8040-220	215 - 224	150	110	250	
* TWPB-8040-230	225 - 234	150	120	250	
* TWPB-8040-240	235 - 244	150	130	250	
* TWPB-8040-250	245 - 254	150	140	250	
* TWPB-8040-260	255 - 264	150	150	250	
* TWPB-8040-290	265 - 284	150	180	250	
* TWPB-8040-320	285 - 324	150	210	250	
* TWPB-8040-350	325 - 354	150	240	250	
* TWPB-8040-370	355 - 374	150	260	250	
* TWPB-8040-390	375 - 394	150	280	250	
* TWPB-8040-410	395 - 414	150	300	250	

\* Delivery-time on request

### Machine processing

Eurofast® EURO-FIX



### Upright processing

Eurofast® EASYTOOL-PRO



Machine processing					
Product key	Clamping	Dimensions			☒
	mm	Tube	Screw		
* TWPBG-8040-040	31 - 44	30	50	750	
* TWPBG-8040-050	45 - 54	30	60	750	
* TWPBG-8040-060	55 - 64	30	70	750	
* TWPBG-8040-070	65 - 74	30	80	750	
* TWPBG-8040-080	75 - 84	60	60	750	
* TWPBG-8040-090	85 - 94	60	70	750	
* TWPBG-8040-100	95 - 104	60	80	750	
* TWPBG-8040-110	105 - 114	60	90	750	
* TWPBG-8040-120	115 - 124	90	70	750	
* TWPBG-8040-130	125 - 134	90	80	750	
* TWPBG-8040-140	135 - 144	90	90	750	
* TWPBG-8040-150	145 - 154	120	70	750	

Machine processing					
Product key	Clamping	Dimensions			☒
	mm	Tube	Screw		
* TWPBG-8040-160	155 - 164	120	80	750	
* TWPBG-8040-170	165 - 174	120	90	600	
* TWPBG-8040-180	175 - 184	150	70	600	
* TWPBG-8040-190	185 - 194	150	80	600	
* TWPBG-8040-200	195 - 204	150	90	600	
* TWPBG-8040-210	205 - 214	150	100	600	
* TWPBG-8040-220	215 - 224	150	110	600	
* TWPBG-8040-230	225 - 234	150	120	600	
* TWPBG-8040-240	235 - 244	150	130	450	
* TWPBG-8040-250	245 - 254	150	140	450	
* TWPBG-8040-260	255 - 264	150	150	450	

\* Delivery-time on request

Tube washer combination for steel substrates  $\leq \max 2 \times 1.25 \text{ mm}$

# EUROFAST® TLKB-45

15 CYCLES KESTERNICH



Torx 25 drive  
Incl. EF-head mark

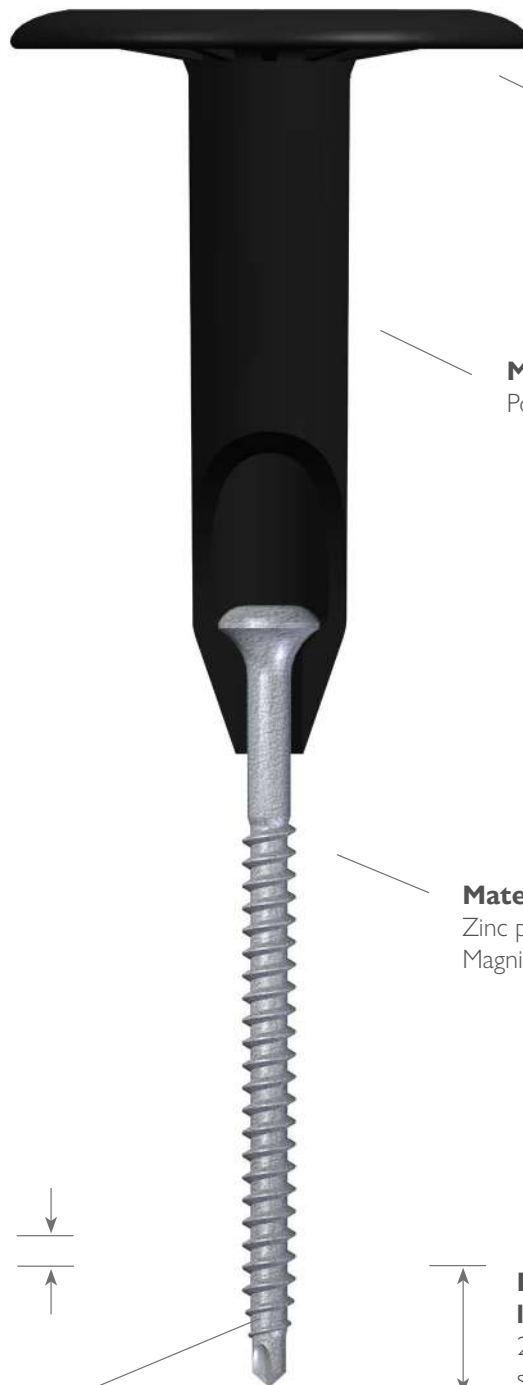

**Diameter**  
 $\varnothing 45 \text{ mm}$

**Material**  
Polypropylene (PP)

**Material**  
Zinc plated with  
Magni-Silver coating

**Steel thickness**  
 $\leq \max 2 \times 1.25 \text{ mm}$

**Point**  
Reduced drill-point

**Recommended  
length of transfix**  
20 mm through the  
steel roofing plate

## Tube washer combination for steel substrates ≤ max 2 x 1.25 mm

Product key	Clamping	Dimensions			✉
	mm	Tube	Screw		
* TLKB-45-050	45 - 54	35	60	250	
* TLKB-45-060	55 - 64	35	70	250	
* TLKB-45-070	65 - 74	35	80	250	
* TLKB-45-080	75 - 84	35	90	250	
* TLKB-45-090	85 - 94	65	70	250	
* TLKB-45-100	95 - 104	65	80	250	
* TLKB-45-110	105 - 114	85	70	250	
* TLKB-45-120	115 - 124	85	80	250	
* TLKB-45-130	125 - 134	105	70	250	
* TLKB-45-140	135 - 144	105	80	250	
* TLKB-45-150	145 - 154	105	90	250	
* TLKB-45-160	155 - 164	135	70	250	
* TLKB-45-170	165 - 174	135	80	250	
* TLKB-45-180	175 - 184	135	90	250	
* TLKB-45-190	185 - 194	165	70	250	
* TLKB-45-200	195 - 204	165	80	250	
* TLKB-45-210	205 - 214	185	70	250	
* TLKB-45-220	215 - 224	185	80	250	
* TLKB-45-230	225 - 234	185	90	250	
* TLKB-45-240	235 - 244	185	100	250	

Product key	Clamping	Dimensions			✉
	mm	Tube	Screw		
* TLKB-45-250	245 - 254	225	70	125	
* TLKB-45-260	255 - 264	225	80	125	
* TLKB-45-270	265 - 274	225	90	125	
* TLKB-45-280	275 - 284	255	70	125	
* TLKB-45-290	285 - 294	255	80	125	
* TLKB-45-300	295 - 304	255	90	125	
* TLKB-45-320	305 - 324	285	80	125	
* TLKB-45-340	325 - 344	285	100	125	
* TLKB-45-360	345 - 364	320	90	125	
* TLKB-45-380	365 - 384	320	110	125	
* TLKB-45-400	385 - 404	320	130	125	
* TLKB-45-420	405 - 424	320	150	125	
* TLKB-45-440	425 - 444	320	180	125	
* TLKB-45-460	445 - 464	320	180	125	
* TLKB-45-470	465 - 474	320	210	125	
* TLKB-45-480	475 - 484	320	210	125	
* TLKB-45-510	485 - 514	320	240	125	
* TLKB-45-530	515 - 534	320	260	125	
* TLKB-45-550	535 - 554	320	280	125	
* TLKB-45-570	555 - 574	320	300	125	

\* Delivery-time on request

### Upright processing

Eurofast® EASYTOOL-PRO



Tube washer combination for steel substrates  $\leq$  max 2 x 1.25 mm

# EUROFAST® TLKB-75

15 CYCLES KESTERNICH



Torx 25 drive  
Incl. EF-head mark

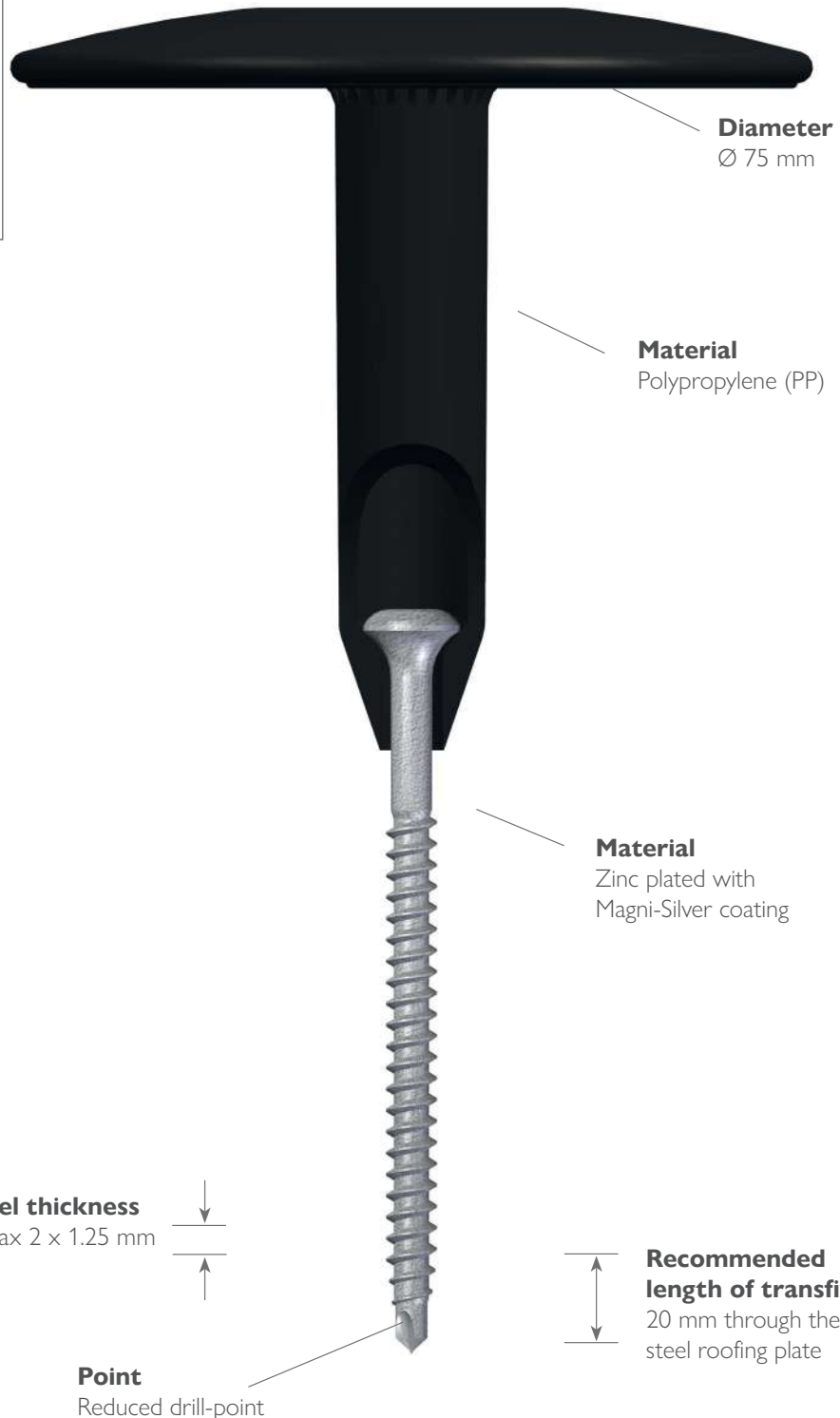



## Tube washer combination for steel substrates ≤ max 2 x 1.25 mm

Product key	Clamping	Dimensions			☒
	mm	Tube	Screw		
* TLKB-75-050	45 - 54	35	60	250	
* TLKB-75-060	55 - 64	35	70	250	
* TLKB-75-070	65 - 74	35	80	250	
TLKB-75-080	75 - 84	35	90	250	
* TLKB-75-090	85 - 94	65	70	250	
TLKB-75-100	95 - 104	65	80	250	
* TLKB-75-110	105 - 114	85	70	250	
TLKB-75-120	115 - 124	85	80	250	
TLKB-75-130	125 - 134	105	70	250	
TLKB-75-140	135 - 144	105	80	250	
TLKB-75-150	145 - 154	105	90	250	
TLKB-75-160	155 - 164	135	70	125	
* TLKB-75-170	165 - 174	135	80	125	
TLKB-75-180	175 - 184	135	90	125	
* TLKB-75-190	185 - 194	165	70	125	
TLKB-75-200	195 - 204	165	80	125	

Product key	Clamping	Dimensions			☒
	mm	Tube	Screw		
TLKB-75-210	205 - 214	185	70	125	
TLKB-75-220	215 - 224	185	80	125	
* TLKB-75-230	225 - 234	185	90	125	
TLKB-75-240	235 - 244	185	100	125	
* TLKB-75-250	245 - 254	185	110	125	
* TLKB-75-260	255 - 264	185	120	125	
* TLKB-75-270	265 - 274	185	130	125	
* TLKB-75-280	275 - 284	185	140	125	
* TLKB-75-290	285 - 294	185	150	125	
* TLKB-75-320	295 - 324	185	180	125	
* TLKB-75-350	345 - 354	185	210	125	
* TLKB-75-380	355 - 384	185	240	125	
* TLKB-75-400	385 - 404	185	260	125	
* TLKB-75-420	405 - 424	185	280	125	
* TLKB-75-440	425 - 444	185	300	125	

\* Delivery-time on request

### Upright processing

Eurofast® EASYTOOL-PRO



Tube washer combination for steel substrates  $\leq \max 2 \times 1.25 \text{ mm}$

# EUROFAST® TRPSRB-45

**BI-METAL (STAINLESS STEEL A4)**



Torx 25 drive  
Incl. EF-head mark



### Extra option

Also belted available  
for machine processing

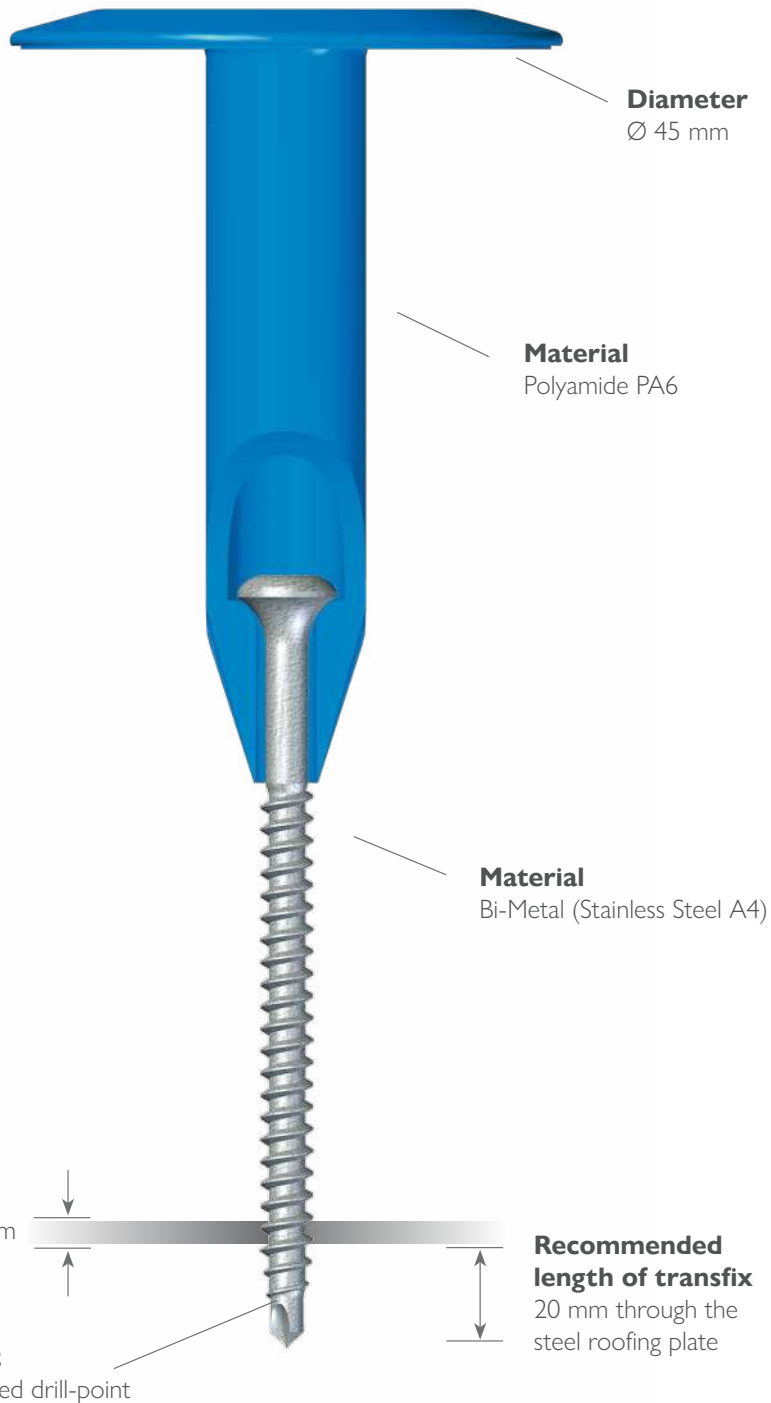

## Tube washer combination for steel substrates ≤ max 2 x 1.25 mm

Product key	Clamping	Dimensions			☒
	mm	Tube	Screw		
* TRPSRB-45-050	45 - 54	30	60	250	
* TRPSRB-45-070	55 - 74	30	80	250	
* TRPSRB-45-080	75 - 84	60	60	250	
* TRPSRB-45-090	85 - 94	30	100	250	
* TRPSRB-45-100	95 - 104	60	80	250	
* TRPSRB-45-110	105 - 114	90	60	250	
* TRPSRB-45-120	115 - 124	60	100	250	
* TRPSRB-45-130	125 - 134	90	80	250	
* TRPSRB-45-140	135 - 144	120	60	250	
* TRPSRB-45-150	145 - 154	90	100	250	
* TRPSRB-45-160	155 - 164	120	80	250	
* TRPSRB-45-170	165 - 174	150	60	250	
* TRPSRB-45-180	175 - 184	120	100	250	

\* Delivery-time on request

Product key	Clamping	Dimensions			☒
	mm	Tube	Screw		
* TRPSRB-45-190	185 - 194	150	80	250	
* TRPSRB-45-200	195 - 204	120	120	250	
* TRPSRB-45-210	205 - 214	150	100	250	
* TRPSRB-45-220	215 - 224	120	140	250	
* TRPSRB-45-230	225 - 234	150	120	250	
* TRPSRB-45-240	235 - 244	120	160	250	
* TRPSRB-45-250	245 - 254	150	140	250	
* TRPSRB-45-260	255 - 264	120	180	250	
* TRPSRB-45-270	265 - 274	150	160	250	
* TRPSRB-45-290	275 - 294	150	180	250	
* TRPSRB-45-320	295 - 324	150	210	250	
* TRPSRB-45-350	325 - 354	150	240	250	

### Machine processing

Eurofast® EURO-FIX



### Upright processing

Eurofast® EASYTOOL-PRO



Machine processing					
Product key	Clamping	Dimensions			☒
	mm	Tube	Screw		
* TRPSRBG-45-050	45 - 54	30	80	1000	
* TRPSRBG-45-070	55 - 74	30	100	1000	
* TRPSRBG-45-080	75 - 84	60	80	1000	
* TRPSRBG-45-090	85 - 94	90	60	1000	
* TRPSRBG-45-100	95 - 104	60	100	1000	
* TRPSRBG-45-110	105 - 114	90	80	1000	
* TRPSRBG-45-120	115 - 124	120	60	1000	
* TRPSRBG-45-130	125 - 134	90	100	1000	
* TRPSRBG-45-140	135 - 144	120	60	1000	
* TRPSRBG-45-150	145 - 154	90	100	1000	
* TRPSRBG-45-160	155 - 164	120	80	1000	

\* Delivery-time on request

Machine processing					
Product key	Clamping	Dimensions			☒
	mm	Tube	Screw		
* TRPSRBG-45-170	165 - 174	150	60	750	
* TRPSRBG-45-180	175 - 184	120	100	750	
* TRPSRBG-45-190	185 - 194	150	80	750	
* TRPSRBG-45-200	195 - 204	120	120	750	
* TRPSRBG-45-210	205 - 214	150	100	750	
* TRPSRBG-45-220	215 - 224	120	140	750	
* TRPSRBG-45-230	225 - 234	150	120	750	
* TRPSRBG-45-240	235 - 244	120	160	600	
* TRPSRBG-45-250	245 - 254	150	140	600	
* TRPSRBG-45-260	255 - 264	120	180	600	

Tube washer combination for steel substrates  $\leq \text{max } 2 \times 1.25 \text{ mm}$

# EUROFAST® BTRPSRB-45

**BI-METAL (STAINLESS STEEL A4)**



Torx 25 drive  
Incl. EF-head mark

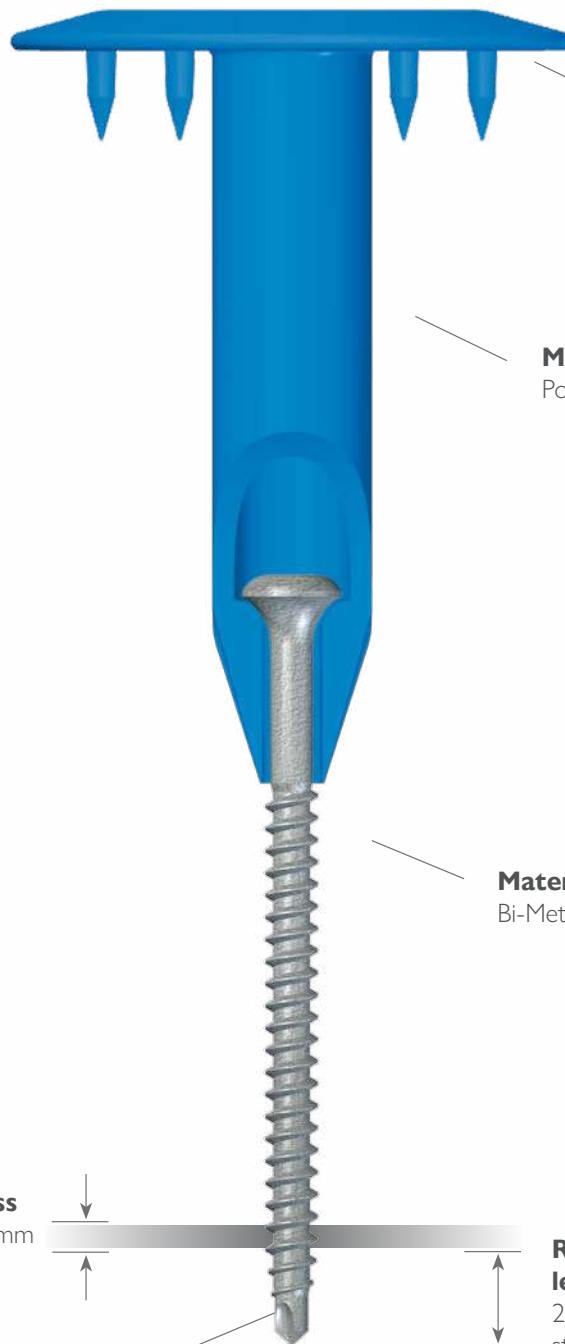

**Diameter**  
 $\varnothing 45 \text{ mm}$

**Material**  
Polyamide PA6

**Material**  
Bi-Metal (Stainless Steel A4)

**Steel thickness**  
 $\leq \text{max } 2 \times 1.25 \text{ mm}$

**Point**  
Reduced drill-point

**Recommended length of transfix**  
20 mm through the steel roofing plate

## Tube washer combination for steel substrates ≤ max 2 x 1.25 mm

Product key	Clamping	Dimensions		
	mm	Tube	Screw	⊠
* BTRPSRB-45-050	45 - 54	30	60	250
* BTRPSRB-45-070	55 - 74	30	80	250
* BTRPSRB-45-080	75 - 84	60	60	250
* BTRPSRB-45-090	85 - 94	30	100	250
* BTRPSRB-45-100	95 - 104	60	80	250
* BTRPSRB-45-110	105 - 114	90	60	250
* BTRPSRB-45-120	115 - 124	60	100	250
* BTRPSRB-45-130	125 - 134	90	80	250
* BTRPSRB-45-140	135 - 144	120	60	250
* BTRPSRB-45-150	145 - 154	90	100	250
* BTRPSRB-45-160	155 - 164	120	80	250
* BTRPSRB-45-170	165 - 174	150	60	250
* BTRPSRB-45-180	175 - 184	120	100	250

Product key	Clamping	Dimensions		
	mm	Tube	Screw	⊠
* BTRPSRB-45-190	185 - 194	150	80	250
* BTRPSRB-45-200	195 - 204	120	120	250
* BTRPSRB-45-210	205 - 214	150	100	250
* BTRPSRB-45-220	215 - 224	120	140	250
* BTRPSRB-45-230	225 - 234	150	120	250
* BTRPSRB-45-240	235 - 244	120	160	250
* BTRPSRB-45-250	245 - 254	150	140	250
* BTRPSRB-45-260	255 - 264	120	180	250
* BTRPSRB-45-270	265 - 274	150	160	250
* BTRPSRB-45-290	275 - 294	150	180	250
* BTRPSRB-45-320	295 - 324	150	210	250
* BTRPSRB-45-350	325 - 354	150	240	250

\* Delivery-time on request

### Upright processing

Eurofast® EASYTOOL-PRO



Tube washer combination for steel substrates  $\leq \max 2 \times 1.25 \text{ mm}$

# EUROFAST® TLKSRB-45

**BI-METAL (STAINLESS STEEL A4)**



Torx 25 drive  
Incl. EF-head mark

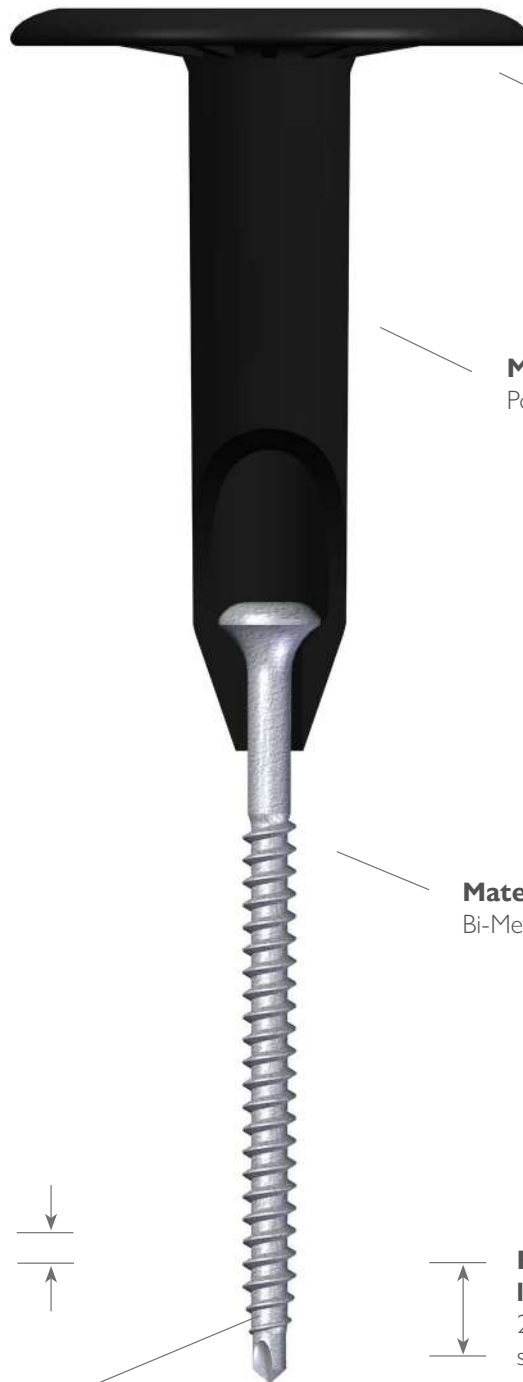

**Diameter**  
 $\varnothing 45 \text{ mm}$

**Material**  
Polypropylene (PP)

**Material**  
Bi-Metal (Stainless Steel A4)

**Steel thickness**  
 $\leq \max 2 \times 1.25 \text{ mm}$

**Point**  
Reduced drill-point

**Recommended length of transfix**  
20 mm through the steel roofing plate

## Tube washer combination for steel substrates ≤ max 2 x 1.25 mm

Product key	Clamping	Dimensions			☒
	mm	Tube	Screw		
* TLKSRB-45-050	45 - 54	35	60	250	
* TLKSRB-45-070	55 - 74	35	80	250	
* TLKSRB-45-080	75 - 84	65	60	250	
* TLKSRB-45-090	85 - 94	35	100	250	
* TLKSRB-45-100	95 - 104	65	80	250	
* TLKSRB-45-110	105 - 114	35	120	250	
* TLKSRB-45-120	115 - 124	85	80	250	
* TLKSRB-45-130	125 - 134	35	140	250	
* TLKSRB-45-140	135 - 144	105	80	250	
* TLKSRB-45-150	145 - 154	135	60	250	
* TLKSRB-45-160	155 - 164	105	100	250	
* TLKSRB-45-170	165 - 174	135	80	250	
* TLKSRB-45-180	175 - 184	165	60	250	
* TLKSRB-45-190	185 - 194	135	100	250	
* TLKSRB-45-200	195 - 204	185	60	250	
* TLKSRB-45-210	205 - 214	135	120	250	
* TLKSRB-45-220	215 - 224	185	80	250	
* TLKSRB-45-230	225 - 234	135	140	250	
* TLKSRB-45-240	235 - 244	225	60	250	
* TLKSRB-45-250	245 - 254	135	160	250	

Product key	Clamping	Dimensions			☒
	mm	Tube	Screw		
* TLKSRB-45-260	255 - 264	225	80	125	
* TLKSRB-45-270	265 - 274	255	60	125	
* TLKSRB-45-280	275 - 284	225	100	125	
* TLKSRB-45-290	285 - 294	255	80	125	
* TLKSRB-45-300	295 - 304	285	60	125	
* TLKSRB-45-310	305 - 314	255	100	125	
* TLKSRB-45-320	315 - 324	285	80	125	
* TLKSRB-45-330	325 - 334	255	120	125	
* TLKSRB-45-340	335 - 344	285	100	125	
* TLKSRB-45-350	345 - 354	185	210	125	
* TLKSRB-45-360	355 - 364	285	120	125	
* TLKSRB-45-370	365 - 374	255	160	125	
* TLKSRB-45-380	375 - 384	285	140	125	
* TLKSRB-45-390	385 - 394	255	180	125	
* TLKSRB-45-400	395 - 404	285	160	125	
* TLKSRB-45-420	405 - 424	320	140	125	
* TLKSRB-45-440	425 - 444	320	160	125	
* TLKSRB-45-460	445 - 464	320	180	125	
* TLKSRB-45-490	465 - 494	320	210	125	
* TLKSRB-45-520	495 - 524	320	240	125	

\* Delivery-time on request

### Upright processing

Eurofast® EASYTOOL-PRO



Tube washer combination for steel substrates  $\leq \max 2 \times 1.25 \text{ mm}$

# EUROFAST® TLKSRB-75

**BI-METAL (STAINLESS STEEL A4)**



Torx 25 drive  
Incl. EF-head mark

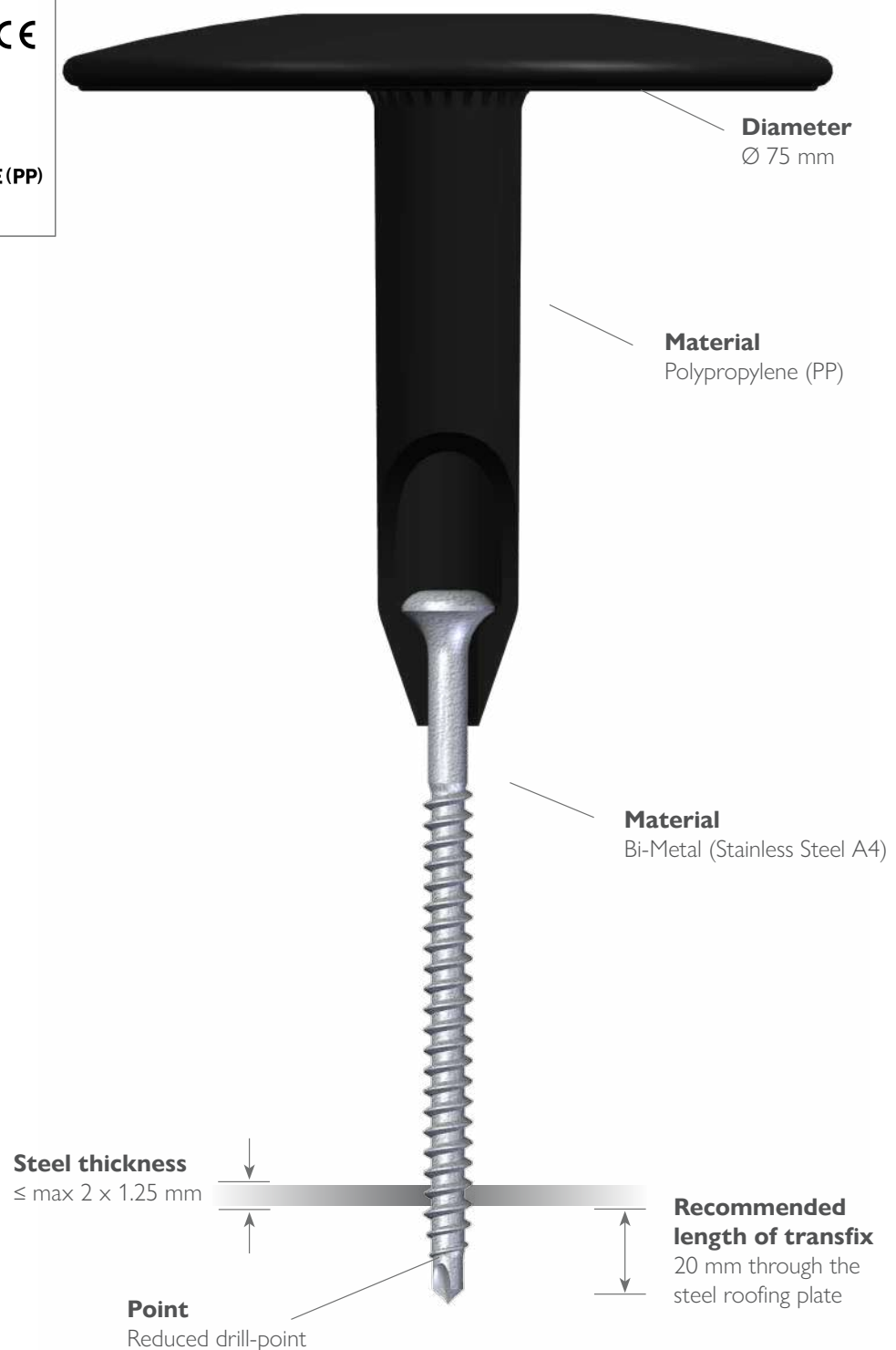



## Tube washer combination for steel substrates ≤ max 2 x 1.25 mm

Product key	Clamping	Dimensions		
	mm	Tube	Screw	⊠
* TLKSRB-75-050	45 - 54	35	60	250
* TLKSRB-75-070	55 - 74	35	80	250
* TLKSRB-75-080	75 - 84	65	60	250
* TLKSRB-75-090	85 - 94	35	100	250
* TLKSRB-75-100	95 - 104	65	80	250
* TLKSRB-75-110	105 - 114	35	120	250
* TLKSRB-75-120	115 - 124	85	80	250
* TLKSRB-75-130	125 - 134	35	140	250
* TLKSRB-75-140	135 - 144	105	80	250
* TLKSRB-75-150	145 - 154	135	60	250
* TLKSRB-75-160	155 - 164	105	100	250
* TLKSRB-75-170	165 - 174	135	80	250
* TLKSRB-75-180	175 - 184	165	60	125
* TLKSRB-75-190	185 - 194	135	100	125
* TLKSRB-75-200	195 - 204	185	60	125

Product key	Clamping	Dimensions		
	mm	Tube	Screw	⊠
* TLKSRB-75-210	205 - 214	135	120	125
* TLKSRB-75-220	215 - 224	185	80	125
* TLKSRB-75-230	225 - 234	135	140	125
* TLKSRB-75-240	235 - 244	185	100	125
* TLKSRB-75-250	245 - 254	135	160	125
* TLKSRB-75-260	255 - 264	185	120	125
* TLKSRB-75-270	265 - 274	135	180	125
* TLKSRB-75-280	275 - 284	185	140	125
* TLKSRB-75-300	285 - 304	185	160	125
* TLKSRB-75-320	305 - 324	185	180	125
* TLKSRB-75-330	325 - 334	165	210	125
* TLKSRB-75-350	335 - 354	185	210	125
* TLKSRB-75-360	355 - 364	165	240	125
* TLKSRB-75-380	365 - 384	185	240	125

\* Delivery-time on request

### Upright processing

Eurofast® EASYTOOL-PRO



## Roofing fasteners for wood substrates

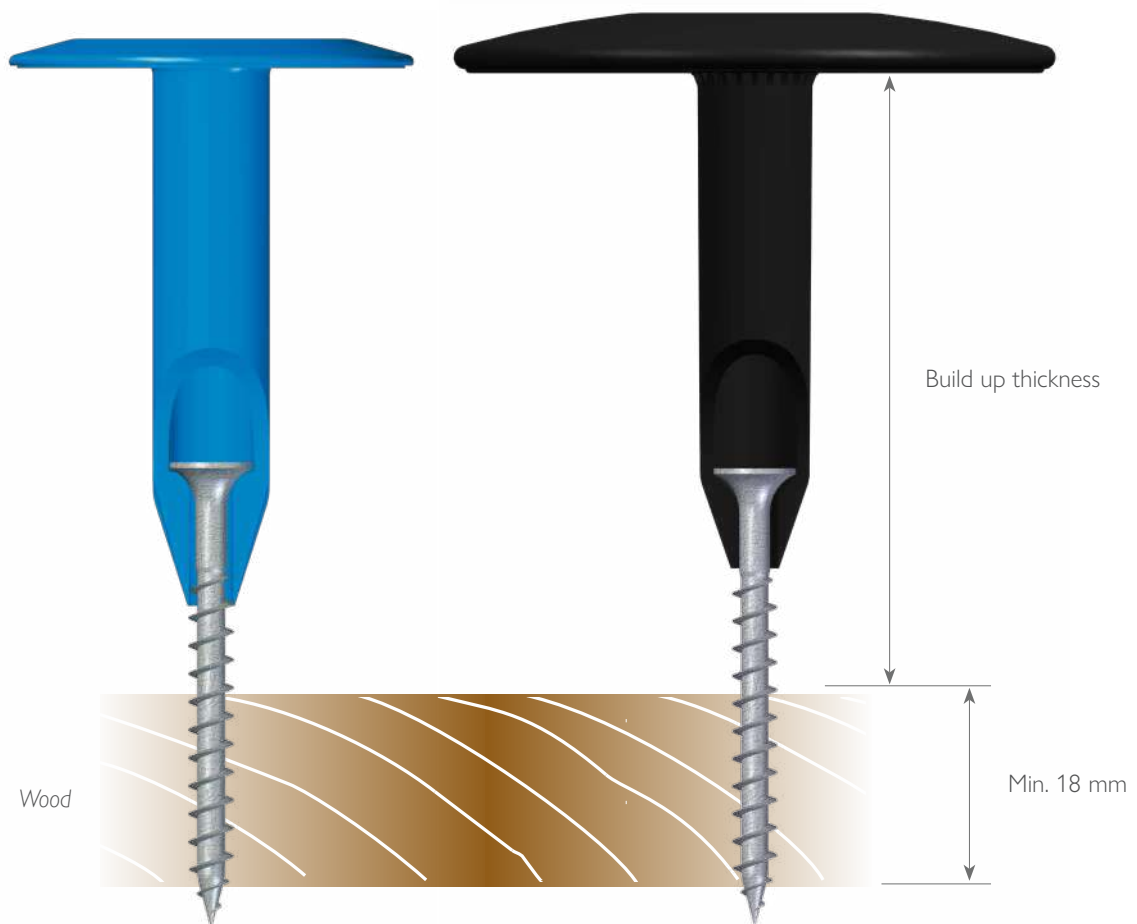
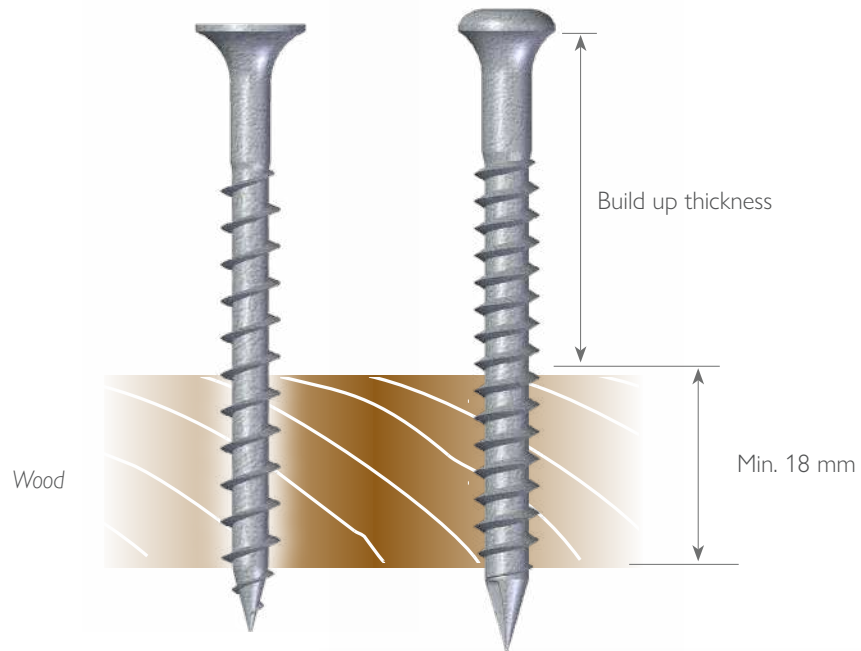

## Roofing fasteners for wood substrates

### 15 cycles Kesternich

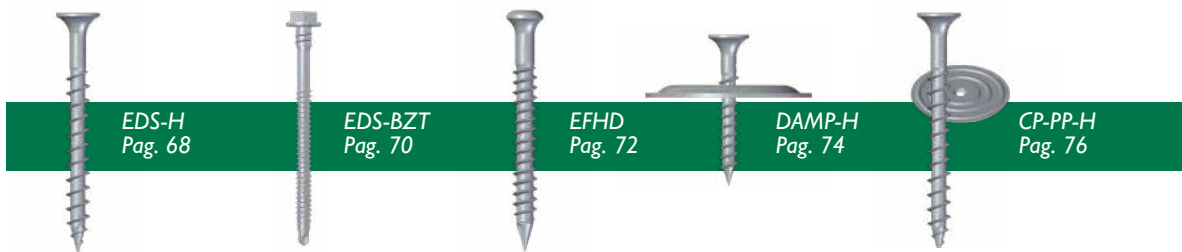

### 15 cycles Kesternich - Tube washer combination

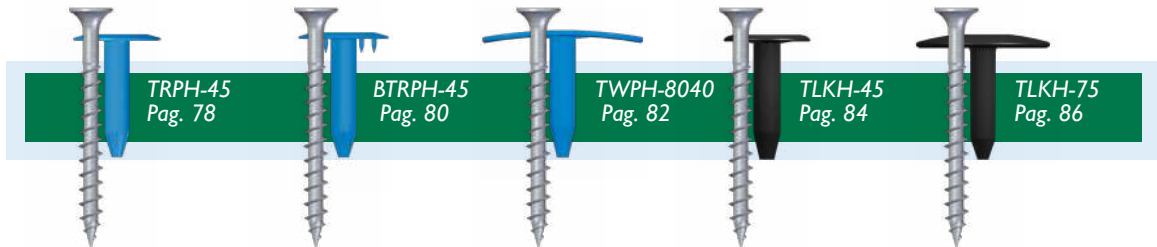

## Wood substrates

**EUROFAST® EDS-H**

15 CYCLES KESTERNICH



PH2 drive  
Incl. EF-head mark

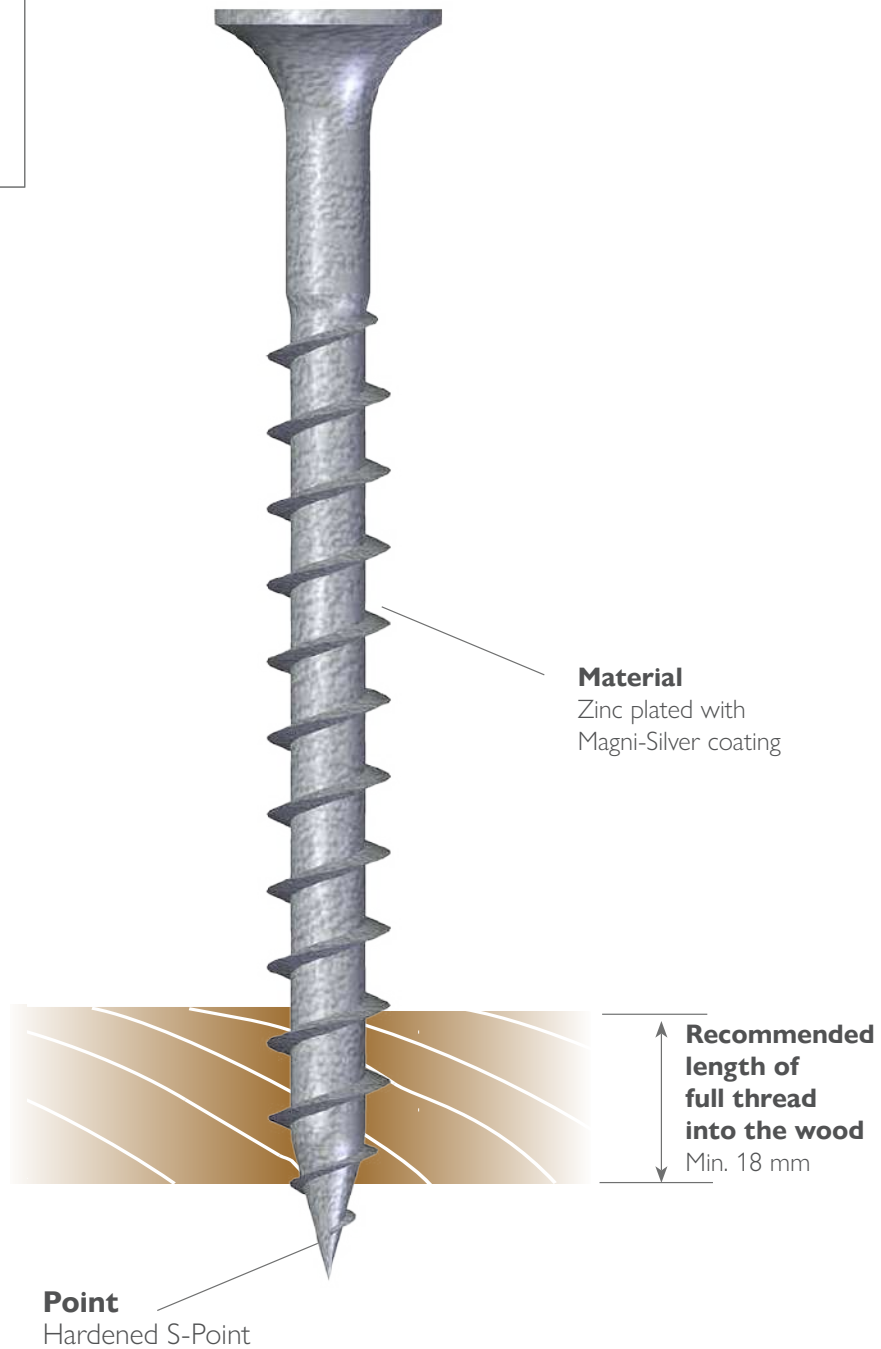

## Wood substrates

Product key	Dimensions			☒
	Ø	Screw	Thread	
EDS-H-50020	5.0	20	15	1000
EDS-H-50025	5.0	25	20	1000
EDS-H-50030	5.0	30	25	1000
EDS-H-50035	5.0	35	30	1000
EDS-H-50040	5.0	40	35	1000
EDS-H-50045	5.0	45	40	1000
EDS-H-50055	5.0	55	50	1000
EDS-H-50065	5.0	65	50	500
EDS-H-50075	5.0	75	50	500
EDS-H-50095	5.0	95	50	500
EDS-H-50120	5.0	120	50	500

# Wood substrates

## EUROFAST® EDS-BZT

15 CYCLES KESTERNICH



### Extra option

Also belted available for machine processing



HWH 8 mm head  
Incl. EF-head mark



Resistance to foot traffic

**Material**  
Zinc plated with Magni-Silver coating

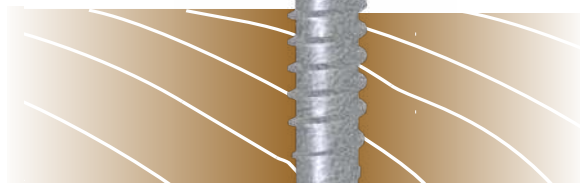

**Recommended length of full thread into the wood**  
Min. 18 mm

**Point**  
Reduced drill-point

## Wood substrates

Product key	Dimensions			
	Ø	Screw	Thread	☒
EDS-BZT48060	4.8	60	50	500
EDS-BZT48070	4.8	70	50	500
EDS-BZT48080	4.8	80	50	500
EDS-BZT48090	4.8	90	50	500
EDS-BZT48100	4.8	100	50	500
EDS-BZT48120	4.8	120	75	500
EDS-BZT48140	4.8	140	75	500
EDS-BZT48160	4.8	160	105	500
EDS-BZT48180	4.8	180	120	500
EDS-BZT48200	4.8	200	120	500
EDS-BZT48220	4.8	220	120	500
EDS-BZT48240	4.8	240	120	500
EDS-BZT48260	4.8	260	120	500
EDS-BZT48280	4.8	280	120	500
EDS-BZT48300	4.8	300	120	500

### Machine processing

Eurofast® DEK-FIX



### Machine processing

EDS-BGT48060	4.8	60	50	1200
EDS-BGT48070	4.8	70	50	1200
EDS-BGT48080	4.8	80	50	1200
EDS-BGT48090	4.8	90	50	1200
EDS-BGT48100	4.8	100	50	1050
EDS-BGT48120	4.8	120	75	1050
EDS-BGT48140	4.8	140	75	750
EDS-BGT48160	4.8	160	105	750
EDS-BGT48180	4.8	180	120	750
EDS-BGT48200	4.8	200	120	750
EDS-BGT48220	4.8	220	120	750
EDS-BGT48240	4.8	240	120	750

## Wood substrates

# EUROFAST® EFHD

15 CYCLES KESTERNICH



Torx 25 drive  
Incl. EF-head mark

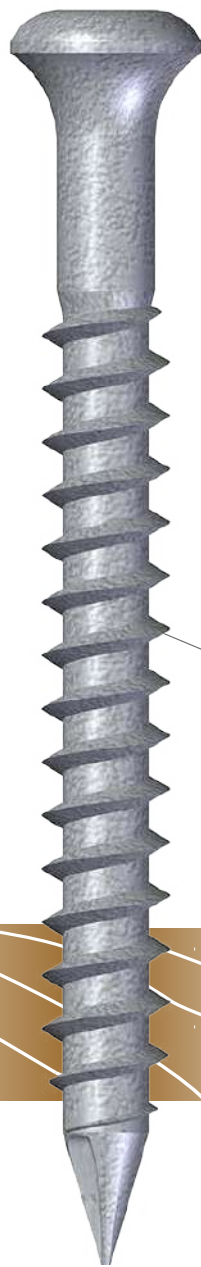

**Material**  
Zinc plated with  
Magni-Silver coating

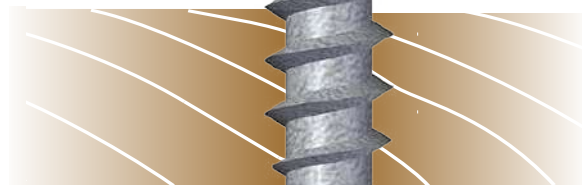

**Recommended  
length of  
full thread  
into the wood**  
Min. 18 mm

**Point**  
Ricoh-point



## Wood substrates

Product key	Dimensions			☒
	Ø	Screw	Thread	
EFHD-63030	6.3	30	25	1000
EFHD-63045	6.3	45	40	1000
EFHD-63060	6.3	60	55	500
EFHD-63070	6.3	70	60	500
EFHD-63080	6.3	80	60	500
EFHD-63100	6.3	100	70	500
EFHD-63130	6.3	130	70	500
EFHD-63160	6.3	160	70	500
EFHD-63180	6.3	180	70	500
EFHD-63200	6.3	200	70	500
EFHD-63230	6.3	230	70	500
EFHD-63250	6.3	250	70	500
EFHD-63275	6.3	275	70	500
EFHD-63300	6.3	300	70	500
EFHD-63330	6.3	330	70	500
EFHD-63350	6.3	350	70	500
EFHD-63400	6.3	400	70	250

## Wood substrates

# EUROFAST® DAMP-H

15 CYCLES KESTERNICH



PH2 drive  
Incl. EF-head mark

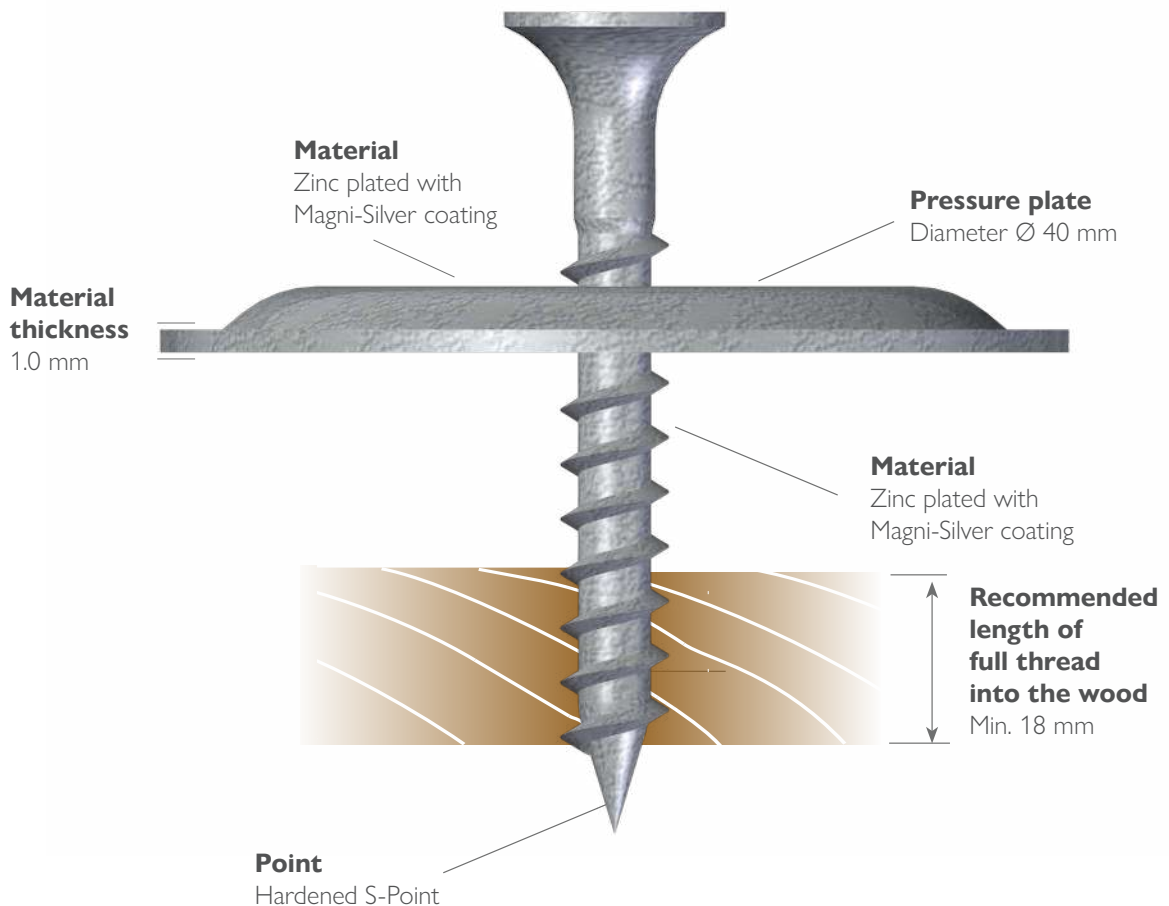

## Wood substrates

Product key	Dimensions			☒
	Ø	Screw	Thread	
DAMP-50020H	5.0	20	15	250
DAMP-50025H	5.0	25	20	250
DAMP-50030H	5.0	30	25	250
DAMP-50035H	5.0	35	30	250
DAMP-50040H	5.0	40	35	250
DAMP-50045H	5.0	45	40	250
DAMP-50055H	5.0	55	50	250
DAMP-50065H	5.0	65	50	250
DAMP-50075H	5.0	75	50	250
DAMP-50095H	5.0	95	50	250
DAMP-50120H	5.0	120	50	250

### Upright processing

Eurofast® EASYTOOL-DAMP



#### Screw bit

PH2 M6

Diameter Ø 8 mm

240260525065

## Wood substrates

## EUROFAST® CP-PP-H

15 CYCLES KESTERNICH

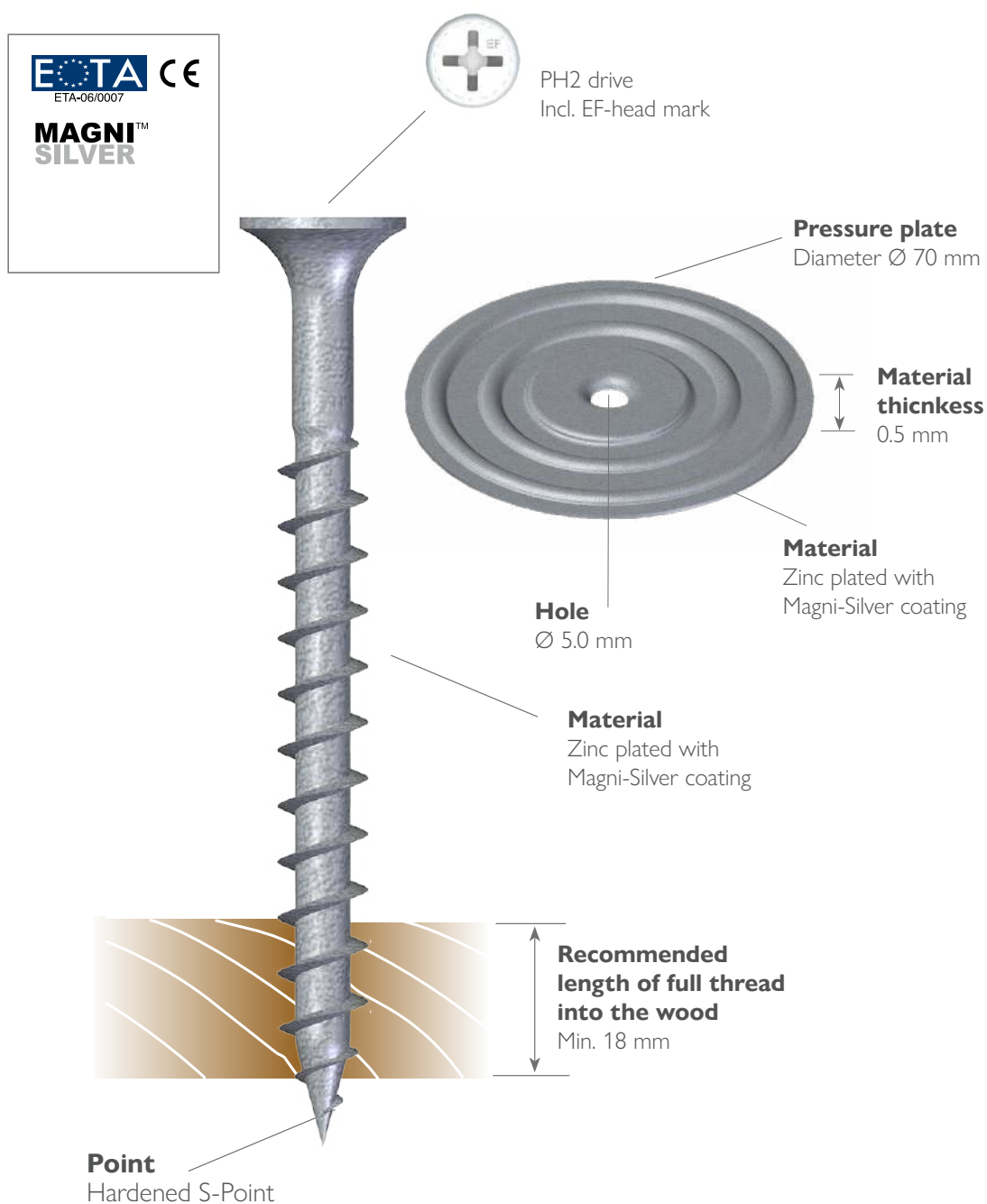

## Wood substrates

Product key	Dimensions			☒
	Ø	Screw	Thread	
CP-PP-50020H	5.0	20	15	250
CP-PP-50025H	5.0	25	20	250
CP-PP-50035H	5.0	35	30	250
CP-PP-50045H	5.0	45	40	250
CP-PP-50055H	5.0	55	50	250
CP-PP-50075H	5.0	75	50	250
CP-PP-50095H	5.0	95	50	250
CP-PP-50120H	5.0	120	50	250

## Tube washer combination for wood substrates

# EUROFAST® TRPH-45

15 CYCLES KESTERNICH



PH2 drive  
Incl. EF-head mark



### Extra option

Also belted available  
for machine processing

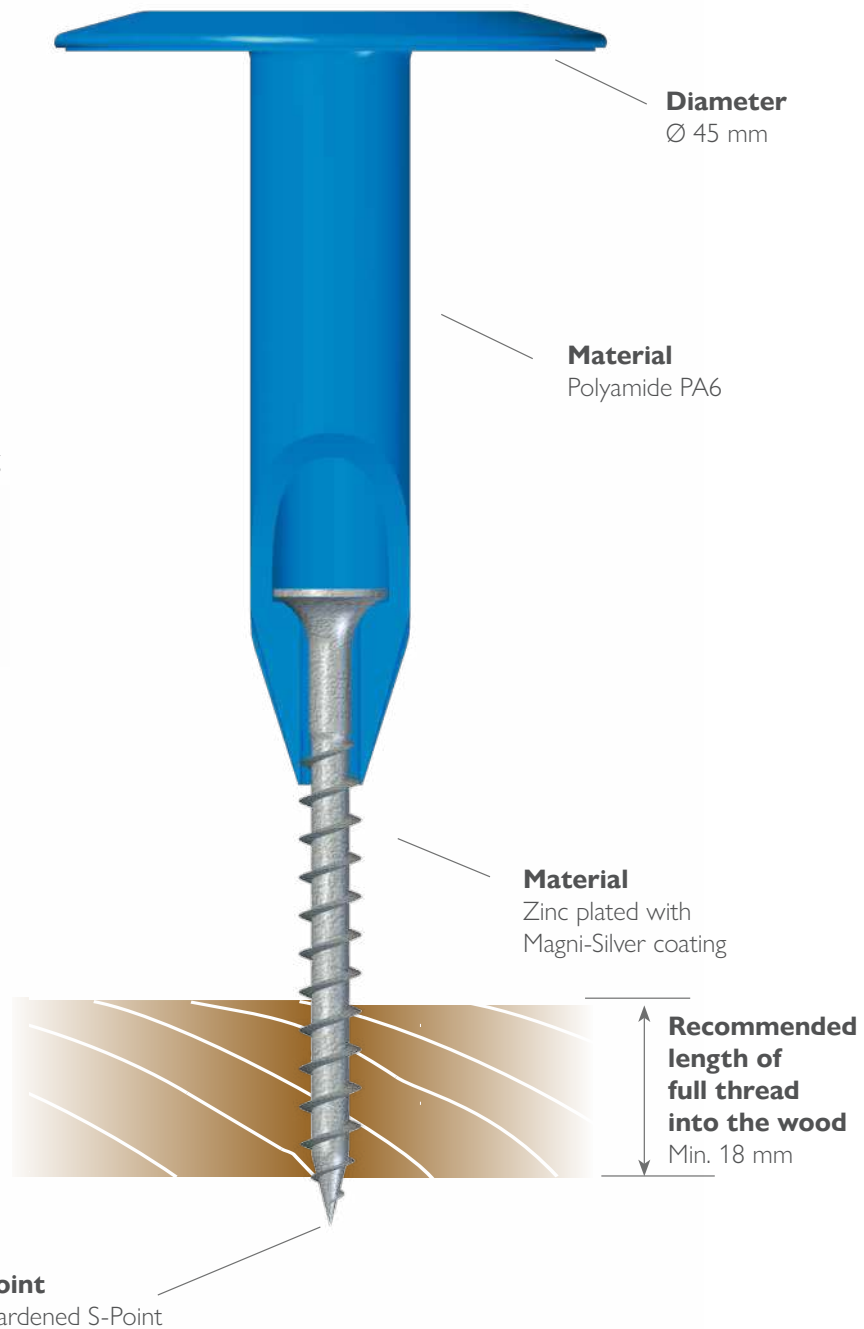

## Tube washer combination for wood substrates

Product key	Clamping	Dimensions			✉
	mm	Tube	Screw		
* TRPH-45-050	45 - 54	30	65	250	
* TRPH-45-060	55 - 64	30	75	250	
* TRPH-45-080	65 - 84	60	65	250	
* TRPH-45-090	85 - 94	60	75	250	
* TRPH-45-110	95 - 114	90	65	250	
* TRPH-45-120	115 - 124	90	75	250	
* TRPH-45-140	125 - 144	120	65	250	
* TRPH-45-150	145 - 154	120	75	250	
* TRPH-45-170	155 - 174	150	65	250	

Product key	Clamping	Dimensions			✉
	mm	Tube	Screw		
* TRPH-45-180	175 - 184	150	75	250	
* TRPH-45-195	185 - 210	150	95	250	
* TRPH-45-225	211 - 235	150	120	250	
* TRPH-45-250	236 - 265	225	75	250	
* TRPH-45-275	266 - 285	225	95	250	
* TRPH-45-300	286 - 310	225	120	250	
* TRPH-45-315	311 - 325	285	75	250	
* TRPH-45-335	326 - 345	285	95	250	
* TRPH-45-360	346 - 375	285	120	250	

\* Delivery-time on request

### Machine processing

Eurofast® EURO-FIX



### Upright processing

Eurofast® EASYTOOL-PRO



Machine processing					
Product key	Clamping	Dimensions			✉
	mm	Tube	Screw		
* TRPHG-45-050	45 - 54	30	65	1000	
* TRPHG-45-060	55 - 64	30	75	1000	
* TRPHG-45-080	65 - 84	60	65	1000	
* TRPHG-45-090	85 - 94	60	75	1000	
* TRPHG-45-110	95 - 114	90	65	1000	
* TRPHG-45-120	115 - 124	90	75	1000	

Machine processing					
Product key	Clamping	Dimensions			✉
	mm	Tube	Screw		
* TRPHG-45-140	125 - 144	120	65	1000	
* TRPHG-45-150	145 - 154	120	75	1000	
* TRPHG-45-170	155 - 174	150	65	750	
* TRPHG-45-180	175 - 184	150	75	750	
* TRPHG-45-195	185 - 210	150	95	750	
* TRPHG-45-225	211 - 235	150	120	750	

\* Delivery-time on request

## Tube washer combination for wood substrates

# EUROFAST® BTRPH-45

15 CYCLES KESTERNICH



PH2 drive  
Incl. EF-head mark

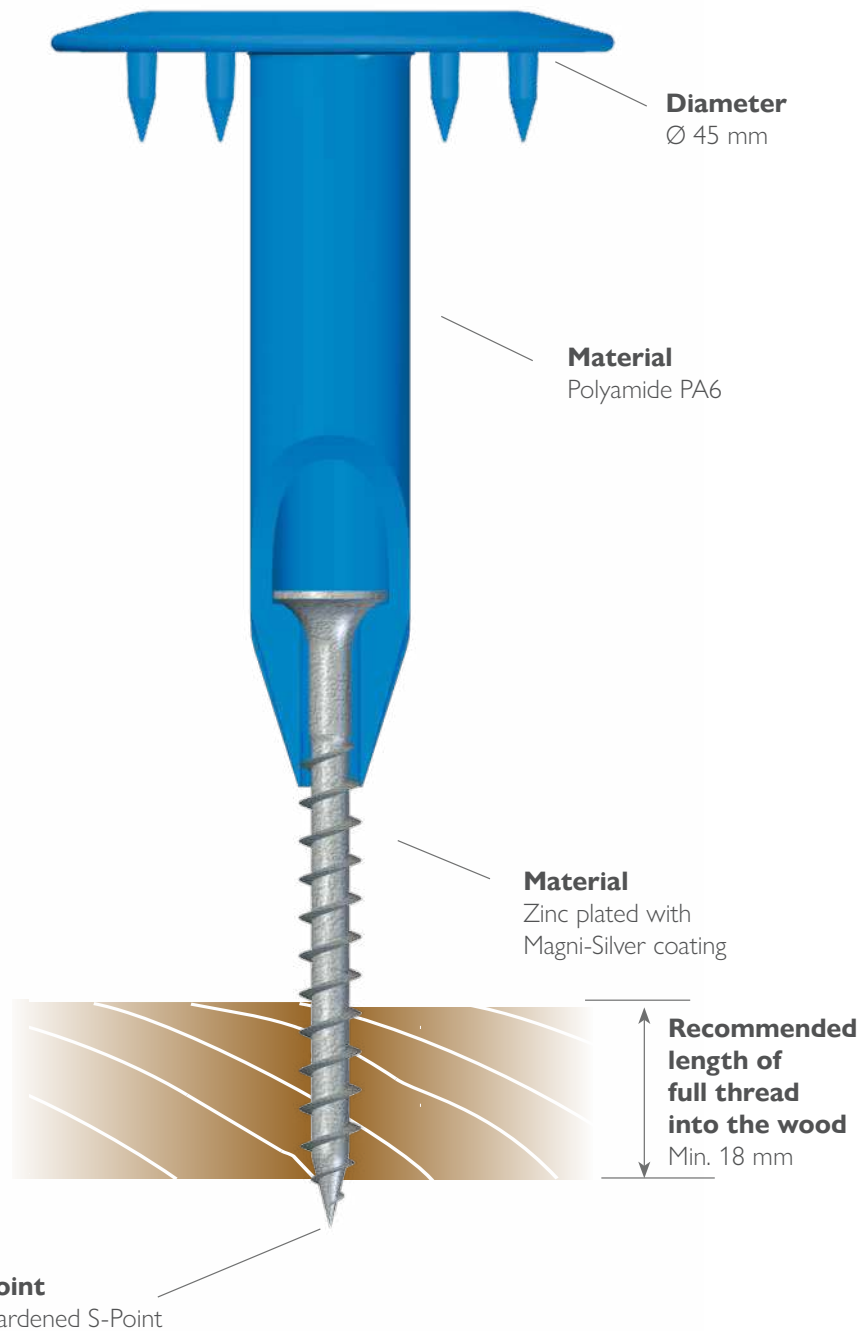



## Tube washer combination for wood substrates

Product key	Clamping	Dimensions		
	mm	Tube	Screw	⊠
* BTRPH-45-050	45 - 54	30	65	250
* BTRPH-45-060	55 - 64	30	75	250
* BTRPH-45-080	65 - 84	60	65	250
* BTRPH-45-090	85 - 94	60	75	250
* BTRPH-45-110	95 - 114	90	65	250
* BTRPH-45-120	115 - 124	90	75	250

Product key	Clamping	Dimensions		
	mm	Tube	Screw	⊠
* BTRPH-45-140	125 - 144	120	65	250
* BTRPH-45-150	145 - 154	120	75	250
* BTRPH-45-170	155 - 174	150	65	250
* BTRPH-45-180	175 - 184	150	75	250
* BTRPH-45-195	185 - 210	150	95	250
* BTRPH-45-225	211 - 235	150	120	250

\* Delivery-time on request

### Upright processing

Eurofast® EASYTOOL-PRO



## Tube washer combination for wood substrates

# EUROFAST® TWPH-8040

15 CYCLES KESTERNICH



PH2 drive  
Incl. EF-head mark

### Extra option

Also belted available  
for machine processing

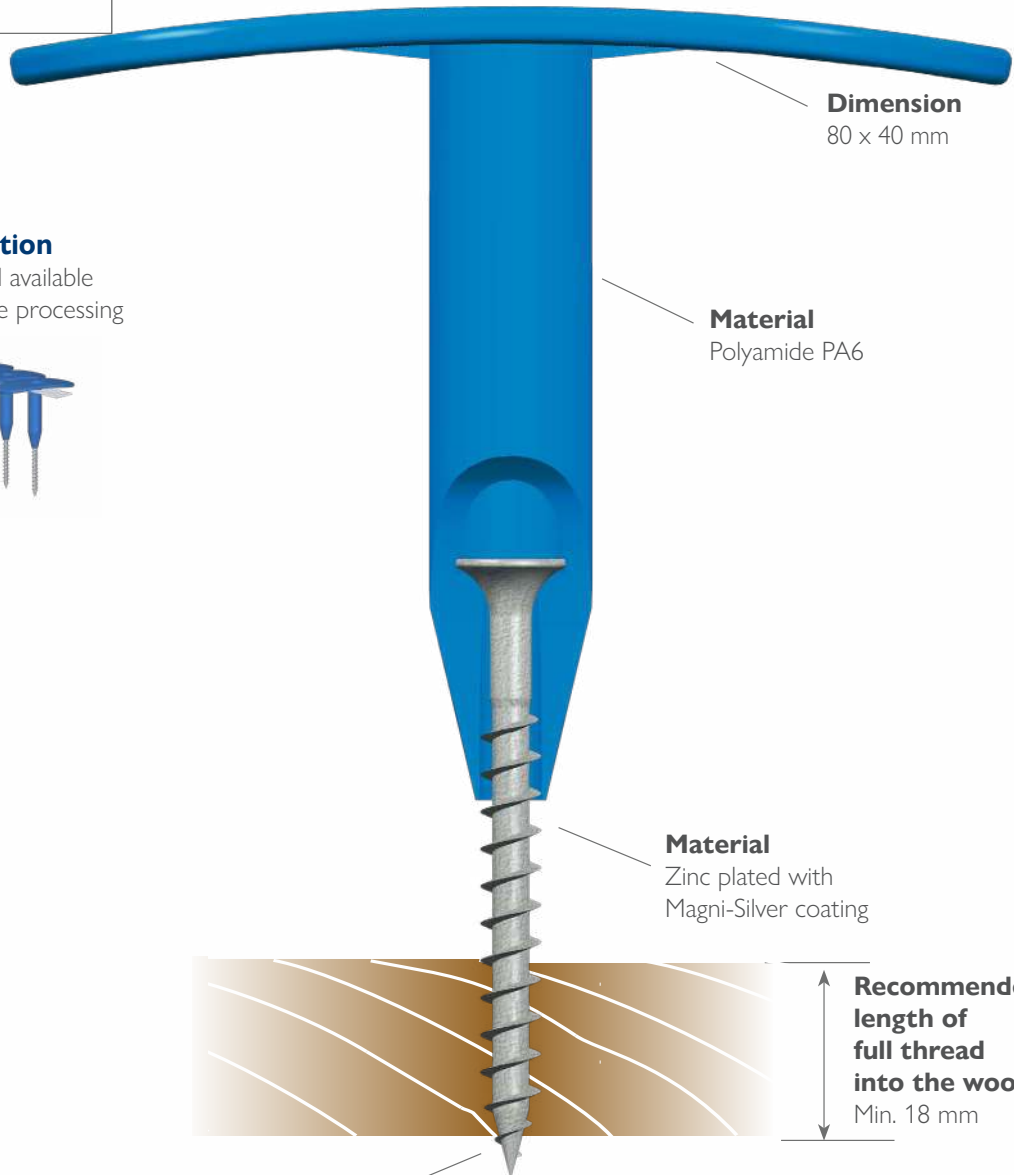

**Dimension**  
80 x 40 mm

**Material**  
Polyamide PA6

**Material**  
Zinc plated with  
Magni-Silver coating

**Recommended  
length of  
full thread  
into the wood**  
Min. 18 mm

**Point**  
Hardened S-Point

## Tube washer combination for wood substrates

Product key	Clamping	Dimensions			☒
	mm	Tube	Screw		
* TWPH-8040-050	45 - 54	30	65	250	
* TWPH-8040-060	55 - 64	30	75	250	
* TWPH-8040-080	65 - 84	60	65	250	
* TWPH-8040-090	85 - 94	60	75	250	
* TWPH-8040-110	95 - 114	90	65	250	
* TWPH-8040-120	115 - 124	90	75	250	

Product key	Clamping	Dimensions			☒
	mm	Tube	Screw		
* TWPH-8040-140	125 - 144	120	65	250	
* TWPH-8040-150	145 - 154	120	75	250	
* TWPH-8040-170	155 - 174	150	65	250	
* TWPH-8040-180	175 - 184	150	75	250	
* TWPH-8040-195	185 - 200	120	120	250	
* TWPH-8040-225	201 - 229	150	120	250	

\* Delivery-time on request

### Machine processing

Eurofast® EURO-FIX



### Upright processing

Eurofast® EASYTOOL-PRO



Machine processing					
Product key	Clamping	Dimensions			☒
	mm	Tube	Screw		
* TWPHG-8040-050	45 - 54	30	65	1000	
* TWPHG-8040-060	55 - 64	30	75	1000	
* TWPHG-8040-080	75 - 84	60	65	1000	
* TWPHG-8040-090	85 - 94	60	75	1000	
* TWPHG-8040-110	105 - 114	90	65	1000	
* TWPHG-8040-120	115 - 124	90	75	750	

Machine processing					
Product key	Clamping	Dimensions			☒
	mm	Tube	Screw		
* TWPHG-8040-140	125 - 144	120	65	500	
* TWPHG-8040-150	145 - 154	120	75	500	
* TWPHG-8040-170	155 - 174	150	65	500	
* TWPHG-8040-180	175 - 184	150	75	500	
* TWPHG-8040-195	185 - 200	120	120	500	
* TWPHG-8040-225	201 - 229	150	120	500	

\* Delivery-time on request

## Tube washer combination for wood substrates

# EUROFAST® TLKH-45

15 CYCLES KESTERNICH



PH2 drive  
Incl. EF-head mark

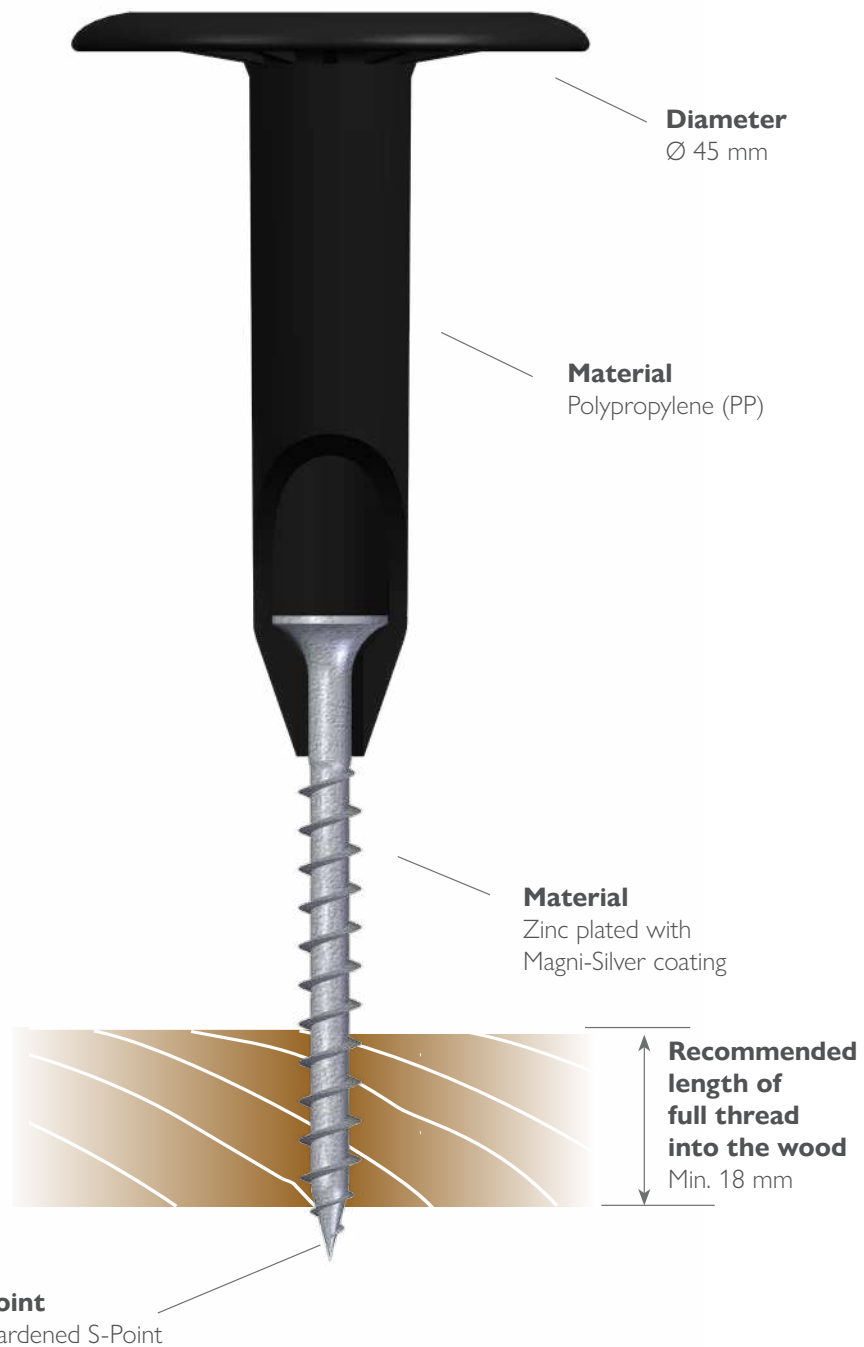

## Tube washer combination for wood substrates

Product key	Clamping	Dimensions		
	mm	Tube	Screw	⊠
* TLKH-45-050	45 - 54	35	65	250
* TLKH-45-060	55 - 64	35	75	250
* TLKH-45-080	65 - 84	65	65	250
* TLKH-45-090	85 - 94	65	75	250
* TLKH-45-110	95 - 114	85	75	250
* TLKH-45-130	115 - 134	105	75	250
* TLKH-45-150	135 - 154	105	95	250
* TLKH-45-160	155 - 164	135	75	250
* TLKH-45-180	165 - 184	135	95	250

Product key	Clamping	Dimensions		
	mm	Tube	Screw	⊠
* TLKH-45-210	185 - 214	135	120	250
* TLKH-45-230	215 - 234	185	95	250
* TLKH-45-260	235 - 264	185	120	250
* TLKH-45-270	265 - 274	225	95	125
* TLKH-45-300	275 - 304	255	95	125
* TLKH-45-330	305 - 334	255	120	125
* TLKH-45-360	335 - 364	285	120	125
* TLKH-45-390	365 - 394	320	120	125

\* Delivery-time on request

### Upright processing

Eurofast® EASYTOOL-PRO



## Tube washer combination for wood substrates

# EUROFAST® TLKH-75

15 CYCLES KESTERNICH



PH2 drive  
Incl. EF-head mark

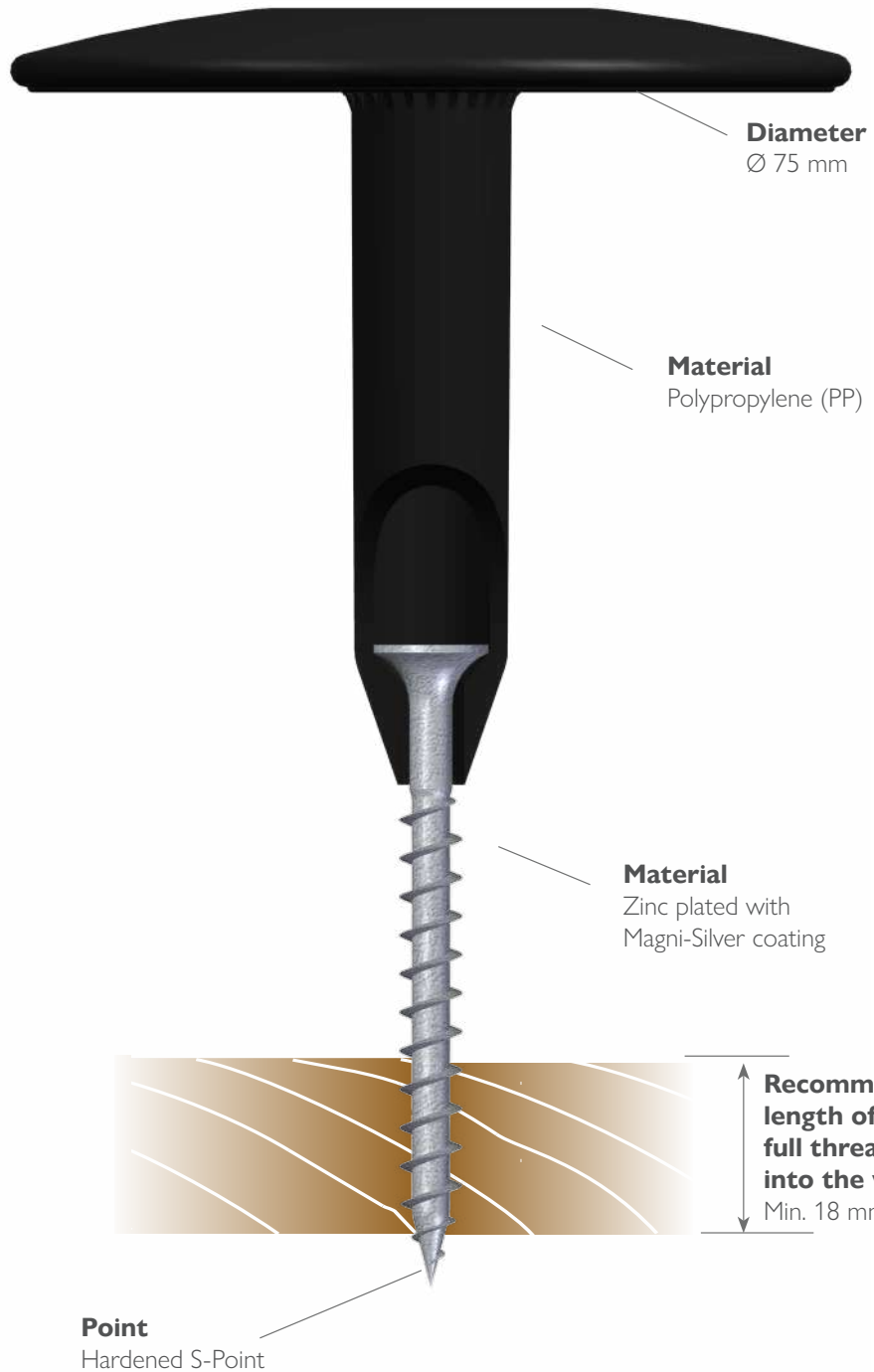

## Tube washer combination for wood substrates

Product key	Clamping	Dimensions		
	mm	Tube	Screw	⊠
* TLKH-75-050	45 - 54	35	65	250
* TLKH-75-060	55 - 64	35	75	250
* TLKH-75-080	65 - 84	65	65	250
* TLKH-75-090	85 - 94	65	75	250
* TLKH-75-110	95 - 114	85	75	250
* TLKH-75-130	115 - 134	105	75	250

Product key	Clamping	Dimensions		
	mm	Tube	Screw	⊠
* TLKH-75-150	135 - 154	105	95	250
* TLKH-75-160	155 - 164	135	75	250
* TLKH-75-180	165 - 184	135	95	125
* TLKH-75-210	185 - 214	185	75	125
* TLKH-75-230	215 - 234	185	95	125
* TLKH-75-260	235 - 264	185	120	125

\* Delivery-time on request

### Upright processing

Eurofast® EASYTOOL-PRO



## Roofing fasteners for lightweight concrete substrates

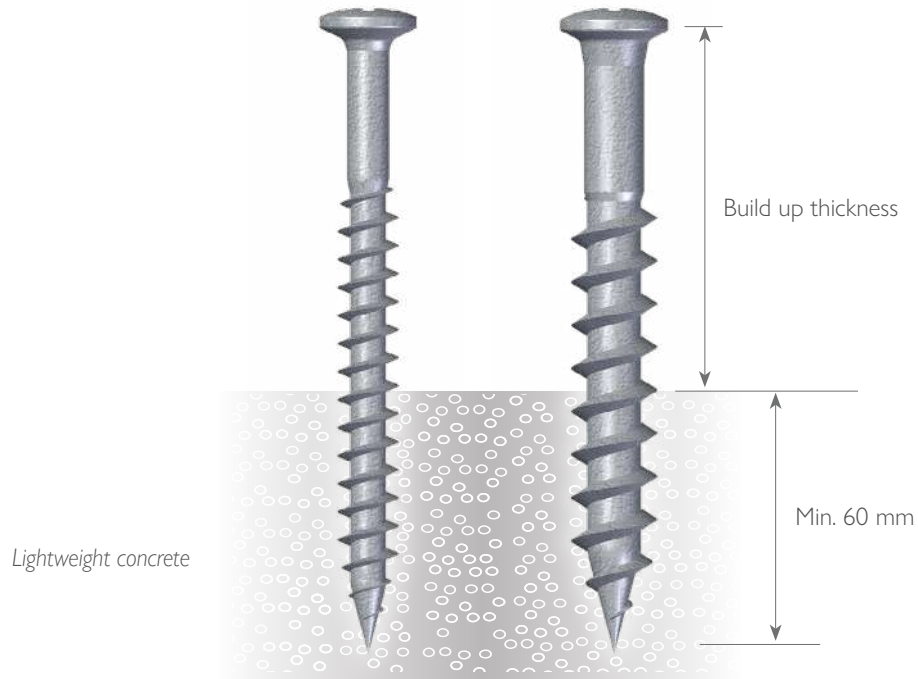



# Roofing fasteners for lightweight concrete substrates

## 15 cycles Kesternich



## Stainless Steel A2



## 15 cycles Kesternich - Tube washer combination



## Stainless Steel A2 - Tube washer combination



## Lightweight concrete substrates

**EUROFAST® GBS-60**

15 CYCLES KESTERNICH



Torx 25 drive  
Incl. EF-head mark

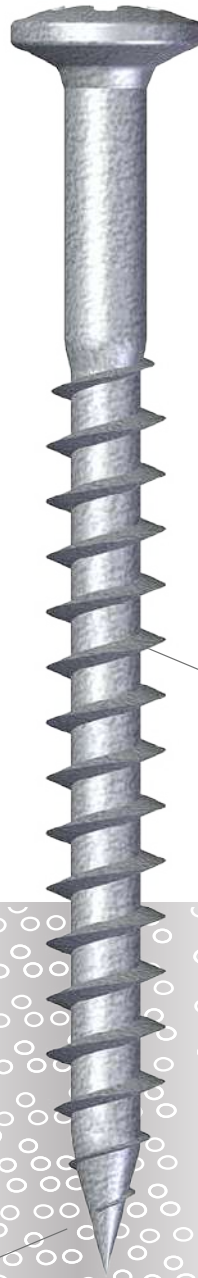

**Material**  
Zinc plated with  
Magni-Silver coating

**Point**  
Hardened S-Point

**Recommended  
length into the  
lightweight  
concrete**  
Min. 60 mm

## Lightweight concrete substrates

Product key	Dimensions			
	Ø	Screw	Thread	⊠
GBS-60060	6.0	60	50	500
GBS-60070	6.0	70	60	500
GBS-60080	6.0	80	70	500
GBS-60090	6.0	90	80	500
GBS-60100	6.0	100	80	500
GBS-60110	6.0	110	80	500
GBS-60120	6.0	120	80	500
GBS-60130	6.0	130	80	500
GBS-60140	6.0	140	80	500
GBS-60160	6.0	160	80	500
GBS-60180	6.0	180	80	500
GBS-60200	6.0	200	80	500

### Rotational speed

The optimal speed to process the Eurofast® GBS-60 is on a low rotational speed.

Advice: 1000 rpm

## Lightweight concrete substrates

**EUROFAST® GBS-80**

15 CYCLES KESTERNICH



Torx 25 drive  
Incl. EF-head mark

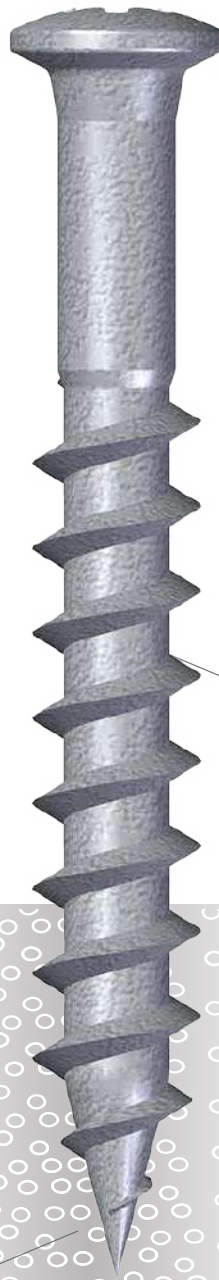

**Material**  
Zinc plated with  
Magni-Silver coating

**Recommended  
length into the  
lightweight  
concrete**  
Min. 60 mm

**Point**  
Hardened S-Point

## Lightweight concrete substrates

Product key	Dimensions			
	Ø	Screw	Thread	⊠
GBS-80065	8.0	65	65	500
GBS-80090	8.0	90	70	500
GBS-80110	8.0	110	70	500
GBS-80130	8.0	130	70	500
GBS-80160	8.0	160	70	500
GBS-80190	8.0	190	70	500
GBS-80240	8.0	240	70	250

### Rotational speed

The optimal speed to process the Eurofast® GBS-80 is on a low rotational speed.

Advice: 1000 rpm

## Lightweight concrete substrates

**EUROFAST® GBSA2****STAINLESS STEEL A2**

Torx 25 drive  
Incl. EF-head mark

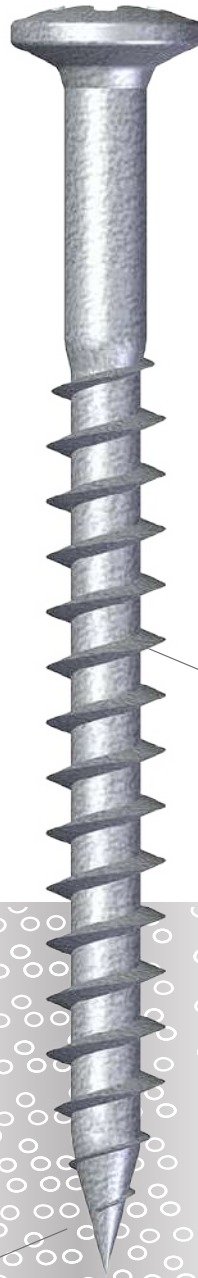
**Material**

Stainless Steel A2 with  
passivated coating

**Point**

Hardened S-Point

**Recommended  
length into the  
lightweight  
concrete**  
Min. 60 mm

## Lightweight concrete substrates

Product key	Dimensions			
	Ø	Screw	Thread	⊠
GBSA2-60100	6.0	100	70	500
GBSA2-60120	6.0	120	80	500
GBSA2-60160	6.0	160	80	500
GBSA2-60200	6.0	200	80	500

### Rotational speed

The optimal speed to process the Eurofast® GBSA2 is on a low rotational speed.

Advice: 1000 rpm

**Tube washer combination for lightweight concrete substrates**

# EUROFAST® TLKGBS-45

15 CYCLES KESTERNICH



Torx 25 drive  
Incl. EF-head mark

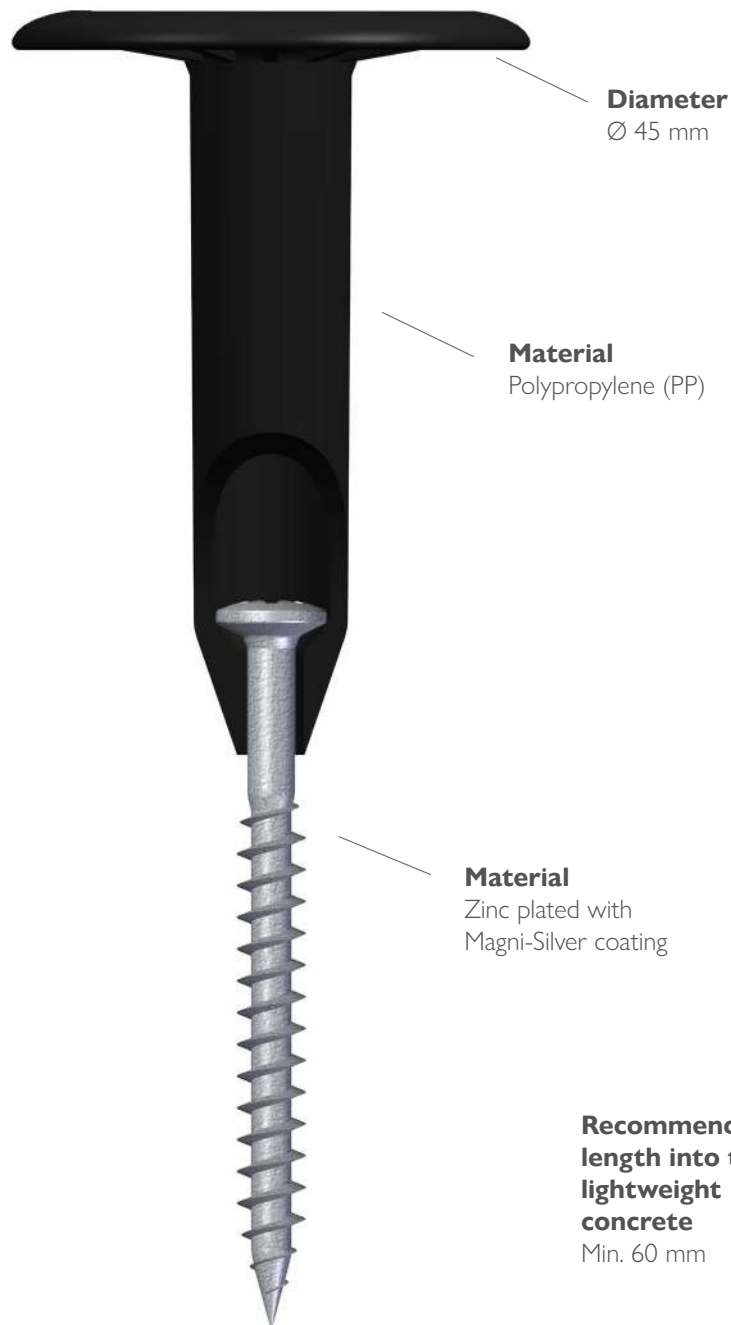

**Diameter**  
Ø 45 mm

**Material**  
Polypropylene (PP)

**Material**  
Zinc plated with  
Magni-Silver coating

**Recommended  
length into the  
lightweight  
concrete**  
Min. 60 mm

**Point**  
Hardened S-Point



## Tube washer combination for lightweight concrete substrates

Product key	Clamping	Dimensions		
	mm	Tube	Screw	⊠
* TLKGBS-45-060	55 - 64	35	100	250
* TLKGBS-45-070	65 - 74	35	110	250
* TLKGBS-45-080	75 - 84	35	120	250
* TLKGBS-45-090	85 - 94	65	100	250
* TLKGBS-45-100	95 - 104	65	110	250
* TLKGBS-45-110	105 - 114	65	120	250
* TLKGBS-45-120	115 - 124	65	130	250
* TLKGBS-45-130	125 - 134	65	140	250
* TLKGBS-45-140	135 - 144	85	130	250
* TLKGBS-45-150	145 - 154	105	120	250
* TLKGBS-45-170	155 - 174	105	140	250
* TLKGBS-45-180	175 - 184	135	120	250
* TLKGBS-45-190	185 - 194	105	160	250
* TLKGBS-45-200	195 - 204	135	140	250
* TLKGBS-45-210	205 - 214	185	100	250
* TLKGBS-45-220	215 - 224	135	160	250
* TLKGBS-45-230	225 - 234	185	120	250

Product key	Clamping	Dimensions		
	mm	Tube	Screw	⊠
* TLKGBS-45-240	235 - 244	185	130	250
* TLKGBS-45-250	245 - 254	185	140	250
* TLKGBS-45-270	255 - 274	225	120	125
* TLKGBS-45-280	275 - 284	225	130	125
* TLKGBS-45-290	285 - 294	225	140	125
* TLKGBS-45-300	295 - 304	255	120	125
* TLKGBS-45-310	305 - 314	255	130	125
* TLKGBS-45-320	315 - 324	255	140	125
* TLKGBS-45-330	325 - 334	255	180	125
* TLKGBS-45-340	335 - 344	255	160	125
* TLKGBS-45-350	345 - 354	255	200	125
* TLKGBS-45-360	355 - 364	255	180	125
* TLKGBS-45-380	365 - 384	320	130	125
* TLKGBS-45-390	385 - 394	320	140	125
* TLKGBS-45-410	395 - 414	320	160	125
* TLKGBS-45-430	415 - 434	320	180	125
* TLKGBS-45-450	435 - 454	320	200	125

\* Delivery-time on request

### Upright processing

Eurofast® EASYTOOL-PRO



#### Rotational speed

The optimal speed to process the Eurofast® TLKGBS-45 is on a low rotational speed.

Advice: 1000 rpm

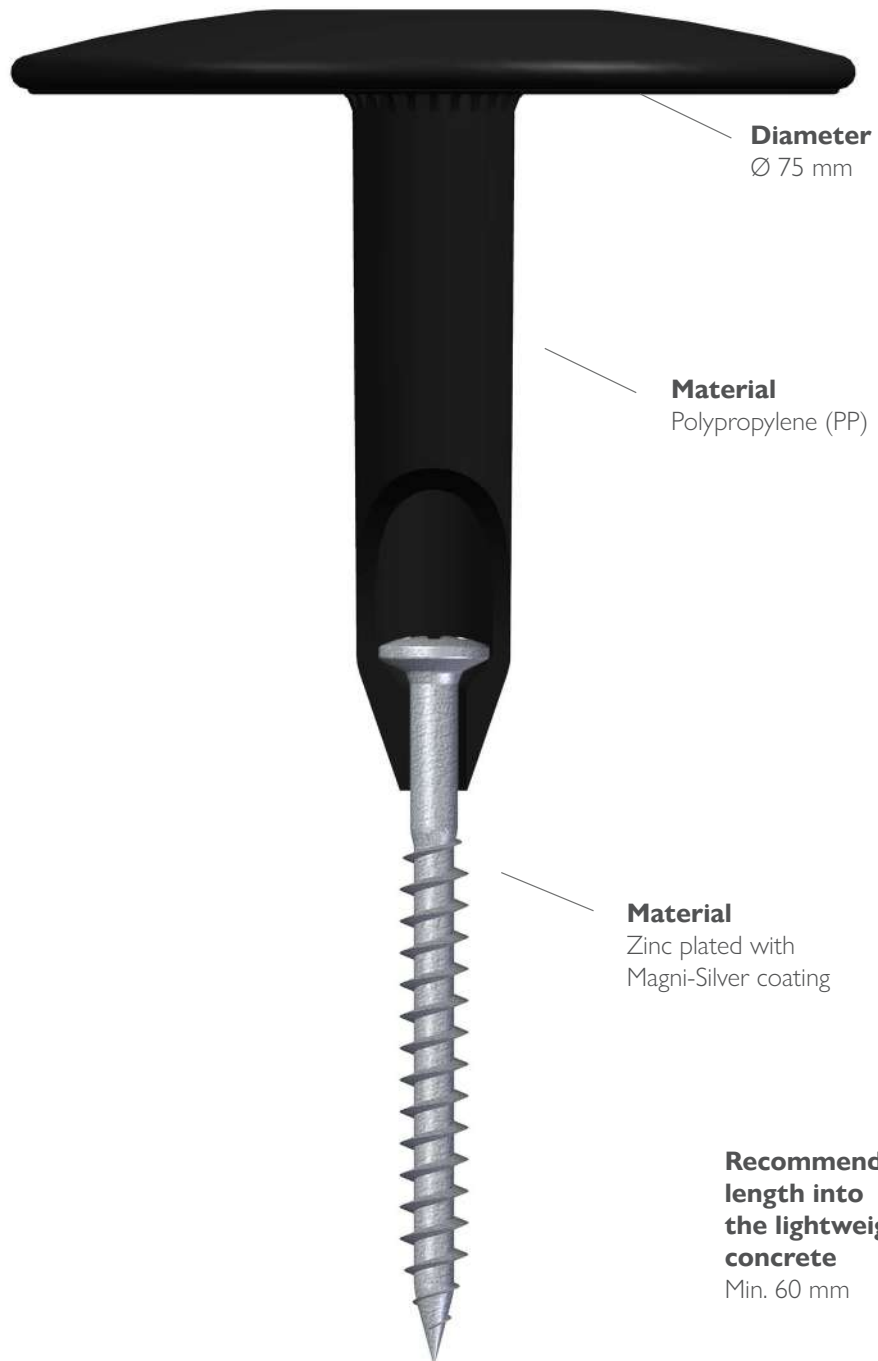
**Tube washer combination for lightweight concrete substrates****EUROFAST® TLKGBS-75****15 CYCLES KESTERNICH**Torx 25 drive  
Incl. EF-head mark**Diameter**  
Ø 75 mm**Material**  
Polypropylene (PP)**Material**  
Zinc plated with  
Magni-Silver coating**Recommended  
length into  
the lightweight  
concrete**  
Min. 60 mm**Point**  
Hardened S-Point

## Tube washer combination for lightweight concrete substrates

Product key	Clamping	Dimensions		
	mm	Tube	Screw	⊠
* TLKGBS-75-060	55 - 64	35	100	250
* TLKGBS-75-070	65 - 74	35	110	250
* TLKGBS-75-080	75 - 84	35	120	250
* TLKGBS-75-090	85 - 94	65	100	250
* TLKGBS-75-100	95 - 104	65	110	250
* TLKGBS-75-110	105 - 114	65	120	250
* TLKGBS-75-120	115 - 124	65	130	250
* TLKGBS-75-130	125 - 134	65	140	250
* TLKGBS-75-140	135 - 144	85	130	250
* TLKGBS-75-150	145 - 154	105	120	250
* TLKGBS-75-170	155 - 174	105	140	250

Product key	Clamping	Dimensions		
	mm	Tube	Screw	⊠
* TLKGBS-75-180	175 - 184	135	120	125
* TLKGBS-75-190	185 - 194	105	160	125
* TLKGBS-75-200	195 - 204	135	140	125
* TLKGBS-75-210	205 - 214	185	100	125
* TLKGBS-75-220	215 - 224	185	110	125
* TLKGBS-75-230	225 - 234	185	120	125
* TLKGBS-75-240	235 - 244	185	130	125
* TLKGBS-75-250	245 - 254	185	140	125
* TLKGBS-75-270	255 - 274	185	160	125
* TLKGBS-75-290	275 - 294	185	180	125
* TLKGBS-75-310	295 - 314	185	200	125

\* Delivery-time on request

### Upright processing

Eurofast® EASYTOOL-PRO



#### Rotational speed

The optimal speed to process the Eurofast® TLKGBS-75 is on a low rotational speed.

Advice: 1000 rpm

Tube washer combination for lightweight concrete substrates

# EUROFAST® TLKGBSA2-45

**STAINLESS STEEL A2**



Torx 25 drive  
Incl. EF-head mark

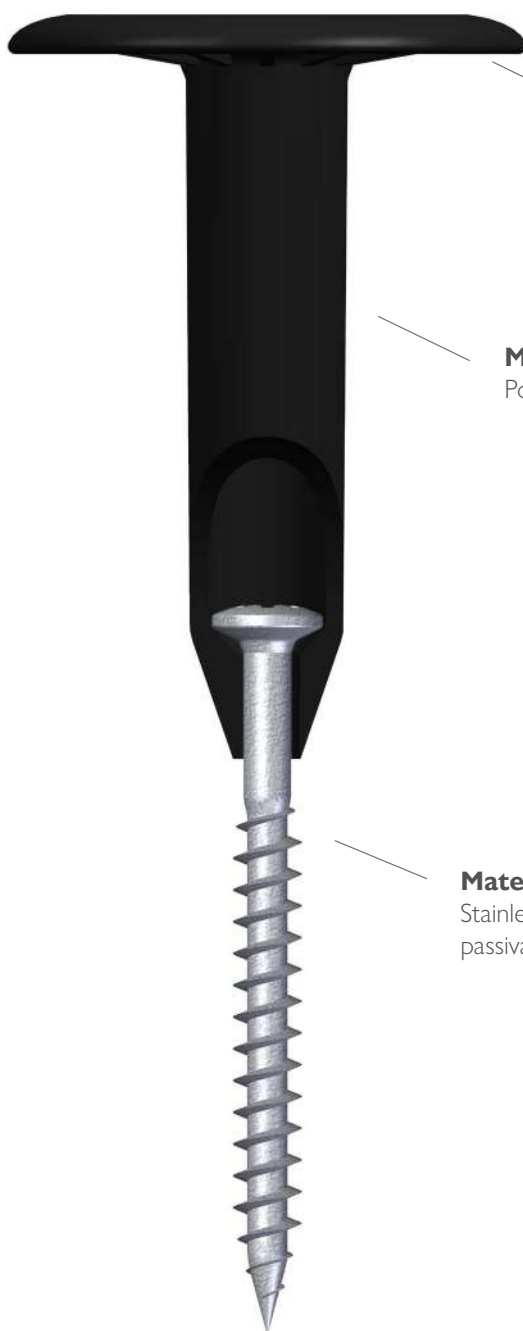

**Diameter**  
Ø 45 mm

**Material**  
Polypropylene (PP)

**Material**  
Stainless Steel A2 with  
passivated coating

**Recommended  
length into  
the lightweight  
concrete**  
Min. 60 mm

**Point**  
Hardened S-Point

## Tube washer combination for lightweight concrete substrates

Product key	Clamping	Dimensions			✉
	mm	Tube	Screw		
* TLKGBSA2-45-060	55 - 64	35	100	250	
* TLKGBSA2-45-080	65 - 84	35	120	250	
* TLKGBSA2-45-090	85 - 94	65	100	250	
* TLKGBSA2-45-110	95 - 114	85	100	250	
* TLKGBSA2-45-120	115 - 124	35	160	250	
* TLKGBSA2-45-130	125 - 134	105	100	250	
* TLKGBSA2-45-150	135 - 154	105	120	250	
* TLKGBSA2-45-160	155 - 164	135	100	250	
* TLKGBSA2-45-170	165 - 174	85	160	250	
* TLKGBSA2-45-180	175 - 184	135	120	250	
* TLKGBSA2-45-190	185 - 194	165	100	250	
* TLKGBSA2-45-210	195 - 214	185	100	250	
* TLKGBSA2-45-220	215 - 224	135	160	250	

Product key	Clamping	Dimensions			✉
	mm	Tube	Screw		
* TLKGBSA2-45-230	225 - 234	185	120	250	
* TLKGBSA2-45-250	235 - 254	225	100	125	
* TLKGBSA2-45-260	255 - 264	135	200	125	
* TLKGBSA2-45-270	265 - 274	225	120	125	
* TLKGBSA2-45-280	275 - 284	255	100	125	
* TLKGBSA2-45-290	285 - 294	165	200	125	
* TLKGBSA2-45-300	295 - 304	255	120	125	
* TLKGBSA2-45-310	305 - 314	225	160	125	
* TLKGBSA2-45-350	315 - 354	320	100	125	
* TLKGBSA2-45-370	355 - 374	320	120	125	
* TLKGBSA2-45-380	375 - 384	255	200	125	
* TLKGBSA2-45-410	385 - 414	320	160	125	
* TLKGBSA2-45-450	415 - 454	320	200	125	

\* Delivery-time on request

### Upright processing

Eurofast® EASYTOOL-PRO



#### Rotational speed

The optimal speed to process the Eurofast® TLKGBSA2-45 is on a low rotational speed. **Advice:**

1000 rpm

Tube washer combination for lightweight concrete substrates

# EUROFAST® TLKGBSA2-75

STAINLESS STEEL A2



Torx 25 drive  
Incl. EF-head mark

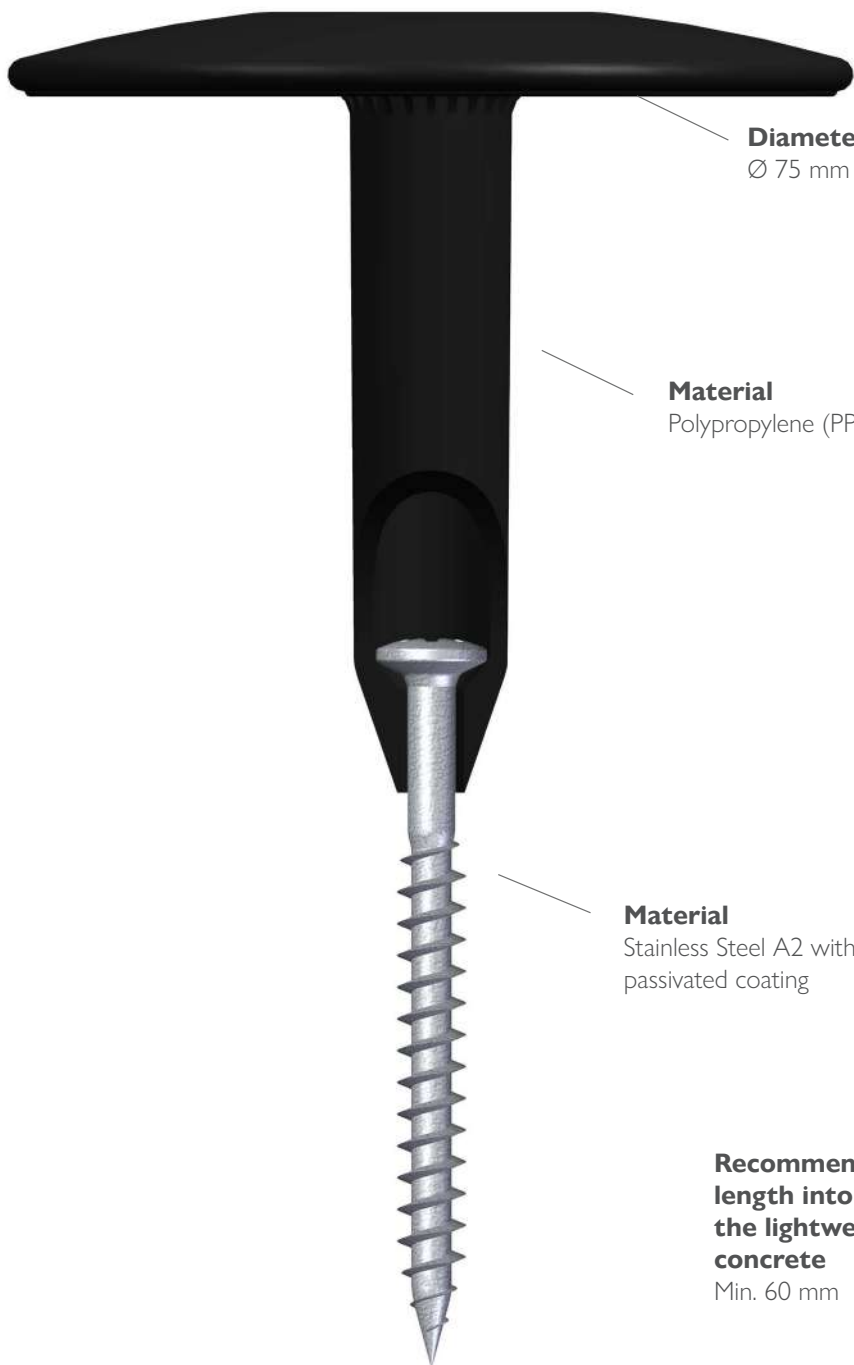

Diameter  
Ø 75 mm

Material  
Polypropylene (PP)

Material  
Stainless Steel A2 with  
passivated coating

Recommended  
length into  
the lightweight  
concrete  
Min. 60 mm

Point  
Hardened S-Point

## Tube washer combination for lightweight concrete substrates

Product key	Clamping	Dimensions		
	mm	Tube	Screw	⊠
* TLKGBSA2-75-060	55 - 64	35	100	250
* TLKGBSA2-75-070	65 - 74	35	120	250
* TLKGBSA2-75-090	75 - 94	65	100	250
* TLKGBSA2-75-100	95 - 104	65	120	250
* TLKGBSA2-75-110	105 - 114	85	100	250
* TLKGBSA2-75-120	115 - 124	35	160	250
* TLKGBSA2-75-130	125 - 134	105	100	250
* TLKGBSA2-75-140	135 - 144	85	140	250
* TLKGBSA2-75-150	145 - 154	105	120	250
* TLKGBSA2-75-160	155 - 164	135	100	250
* TLKGBSA2-75-170	165 - 174	85	160	250

Product key	Clamping	Dimensions		
	mm	Tube	Screw	⊠
* TLKGBSA2-75-180	175 - 184	135	120	125
* TLKGBSA2-75-190	185 - 194	165	100	125
* TLKGBSA2-75-200	195 - 204	135	140	125
* TLKGBSA2-75-210	205 - 214	185	100	125
* TLKGBSA2-75-220	215 - 224	135	160	125
* TLKGBSA2-75-230	225 - 234	185	120	125
* TLKGBSA2-75-240	235 - 244	185	140	125
* TLKGBSA2-75-250	245 - 254	165	160	125
* TLKGBSA2-75-270	255 - 274	185	160	125
* TLKGBSA2-75-290	275 - 294	165	200	125
* TLKGBSA2-75-310	295 - 314	185	200	125

\* Delivery-time on request

### Upright processing

Eurofast® EASYTOOL-PRO



#### Rotational speed

The optimal speed to process the Eurofast® TLKGBSA2-75 is on a low rotational speed. **Advice:**

1000 rpm

## Roofing fasteners for concrete substrates

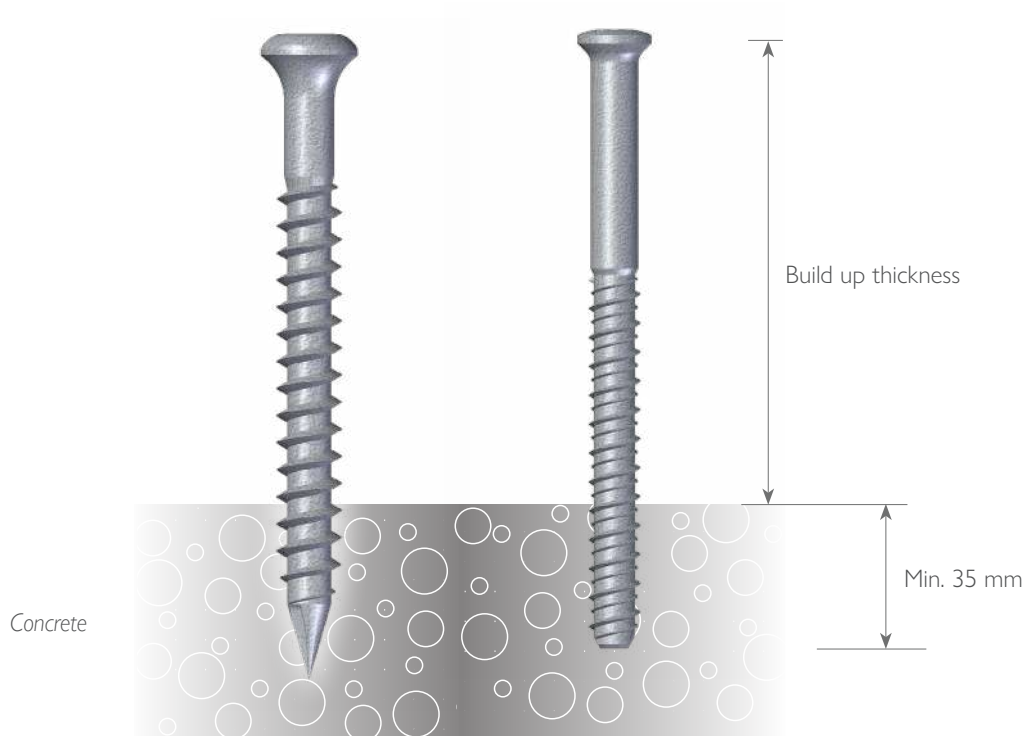



# Roofing fasteners for concrete substrates

## 15 cycles Kesternich



## 30 cycles Kesternich



## Stainless Steel A2



## 15 cycles Kesternich - Tube washer combination - Fastener for tapered insulation

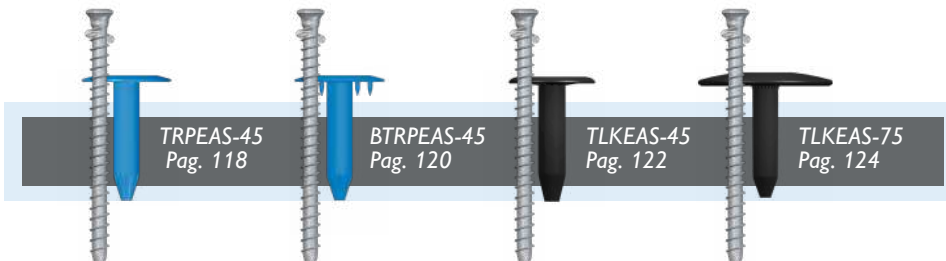

## 15 cycles Kesternich - Tube washer combination

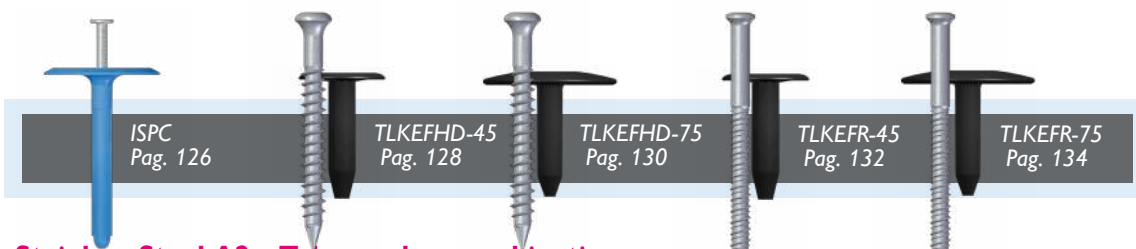

## Stainless Steel A2 - Tube washer combination

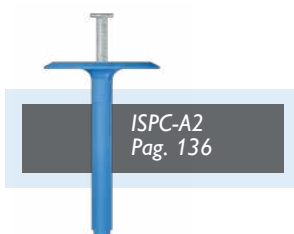

## Concrete substrates

# EUROFAST® EFHD

15 CYCLES KESTERNICH



Torx 25 drive  
Incl. EF-head mark

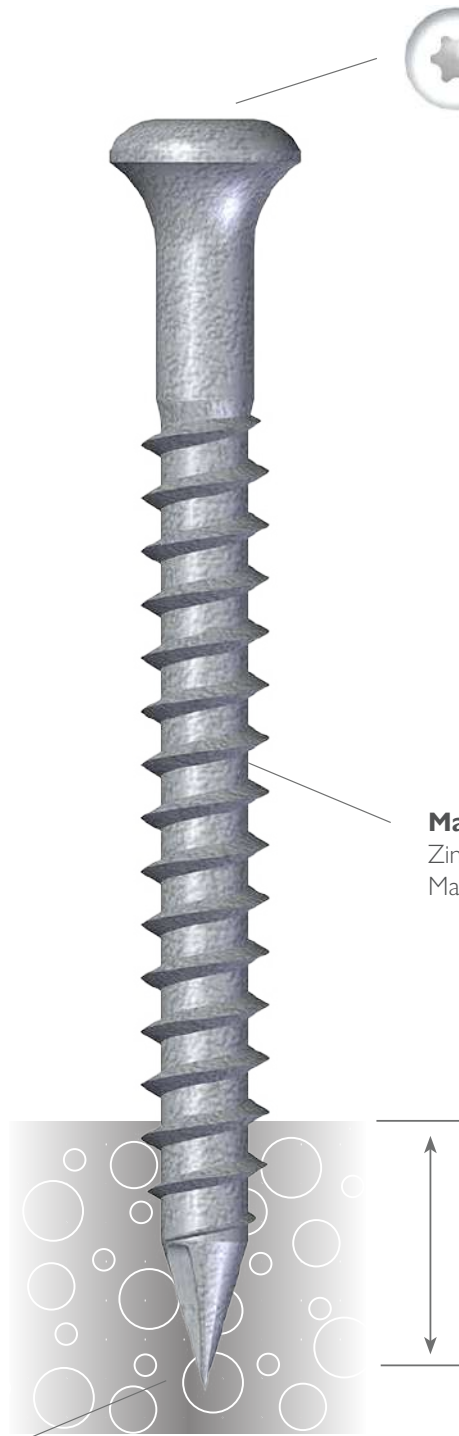

**Material**  
Zinc plated with  
Magni-Silver coating

**Recommended  
length into  
the concrete**  
Min. 35 mm

**Point**  
Ricoh-point

## Concrete substrates

Product key	Dimensions			☒
	Ø	Screw	Thread	
EFHD-63030	6.3	30	25	1000
EFHD-63045	6.3	45	40	1000
EFHD-63060	6.3	60	55	500
EFHD-63070	6.3	70	60	500
EFHD-63080	6.3	80	60	500
EFHD-63100	6.3	100	70	500
EFHD-63130	6.3	130	70	500
EFHD-63160	6.3	160	70	500
EFHD-63180	6.3	180	70	500
EFHD-63200	6.3	200	70	500
EFHD-63230	6.3	230	70	500
EFHD-63250	6.3	250	70	500
EFHD-63275	6.3	275	70	500
EFHD-63300	6.3	300	70	500
EFHD-63330	6.3	330	70	500
EFHD-63350	6.3	350	70	500
EFHD-63400	6.3	400	70	250

### Pre-drilling

Using a drill diameter Ø 5.0, 5.2 or 5.5 mm for pre-drilling. The drilling diameter is dependent on the quality of the concrete. Drilling depth: A minimum of 10 mm deeper than the length of the fastener.

## Concrete substrates

**EUROFAST® EFR**

15 CYCLES KESTERNICH



Torx 25 drive  
Incl. EF-head mark

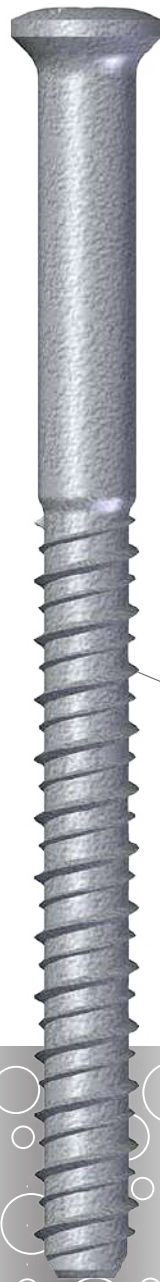

**Material**  
Zinc plated with  
Magni-Silver coating

**Recommended  
length into  
the concrete**  
Min. 35 mm

**Point**  
Blunt point

## Concrete substrates

Product key	Dimensions			
	Ø	Screw	Thread	⊠
EFR-63028	6.3	28	28	500
EFR-63075	6.3	75	50	500
EFR-63085	6.3	85	50	500
EFR-63095	6.3	95	50	500
EFR-63105	6.3	105	50	500
EFR-63120	6.3	120	50	500
EFR-63140	6.3	140	50	500
EFR-63160	6.3	160	60	500
EFR-63180	6.3	180	60	500
EFR-63200	6.3	200	60	500

### Pre-drilling

Using a drill diameter Ø 5.0, 5.2 or 5.5 mm for pre-drilling. The drilling diameter is dependent on the quality of the concrete. Drilling depth: A minimum of 10 mm deeper than the length of the fastener.

Concrete substrates

# EUROFAST® DFCF

15 CYCLES KESTERNICH



HWH 8 mm head  
Incl. EF-head mark

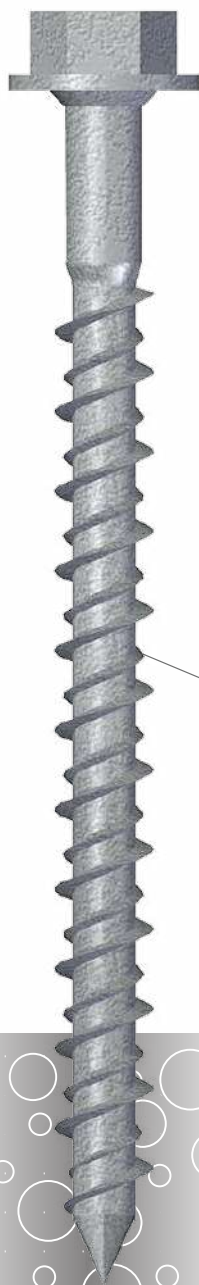

**Material**  
Zinc plated with  
Magni-Silver coating

**Recommended  
length into  
the concrete**  
Min. 35 mm

**Point**  
Diamond nailpunt

## Concrete substrates

Product key	Dimensions			⊠
	Ø	Screw	Thread	
DFCF-63032	6.3	32	32	1000
DFCF-63041	6.3	41	41	1000
DFCF-63057	6.3	57	57	1000
DFCF-63070	6.3	70	60	1000
DFCF-63081	6.3	81	60	1000
DFCF-63094	6.3	94	60	1000
DFCF-63102	6.3	102	60	1000
DFCF-63127	6.3	127	60	1000
DFCF-63140	6.3	140	60	500
DFCF-63152	6.3	152	60	500
DFCF-63178	6.3	178	60	500
DFCF-63203	6.3	203	60	500
DFCF-63229	6.3	229	60	500
DFCF-63254	6.3	254	60	500
DFCF-63278	6.3	278	60	250
DFCF-63305	6.3	305	60	250

### Pre-drilling

Using a drill diameter Ø 5.0, 5.2 or 5.5 mm for pre-drilling. The drilling diameter is dependent on the quality of the concrete. Drilling depth: A minimum of 10 mm deeper than the length of the fastener.

## Concrete substrates

# OMG HD - DFDS-60

**30 CYCLES KESTERNICH**

PH3 driver

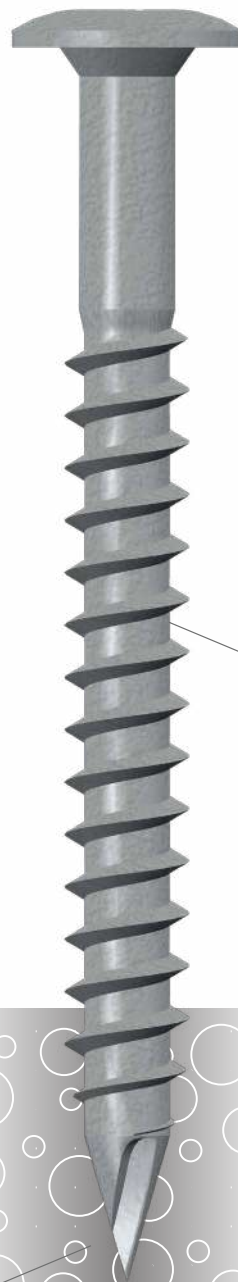

**Material**  
Zinc plated with  
CR-10 coating

**Recommended  
length into  
the concrete**  
Min. 35 mm

**Point**  
Ricoh-punt



## Concrete substrates

Product key	Dimensions			☒
	Ø	Screw	Thread	
DFDS-60030	6.3	30	30	1000
DFDS-60045	6.3	45	45	1000
DFDS-60055	6.3	55	50	1000
DFDS-60075	6.3	75	75	1000
DFDS-60083	6.3	83	75	1000
DFDS-60095	6.3	100	100	1000
DFDS-60115	6.3	115	100	1000
DFDS-60125	6.3	125	100	500
DFDS-60150	6.3	150	100	500
DFDS-60175	6.3	175	100	500
DFDS-60200	6.3	200	100	500
DFDS-60225	6.3	230	100	500
DFDS-60250	6.3	255	100	500
DFDS-60275	6.3	280	100	500
DFDS-60300	6.3	305	100	250
DFDS-60330	6.3	330	100	250
DFDS-60350	6.3	355	100	250
DFDS-60405	6.3	405	100	250
DFDS-60460	6.3	455	125	250
DFDS-60510	6.3	510	125	250
DFDS-60560	6.3	560	125	250
DFDS-60610	6.3	610	125	250

### Pre-drilling

Using a drill diameter Ø 6.0 mm for pre-drilling. Drilling depth: 10 mm less deep than the length of the fastener.

## Concrete substrates

# OMG CD-10 - DCDF

30 CYCLES KESTERNICH



Flat nail head



**Material**  
Zinc plated with  
CR-10 coating

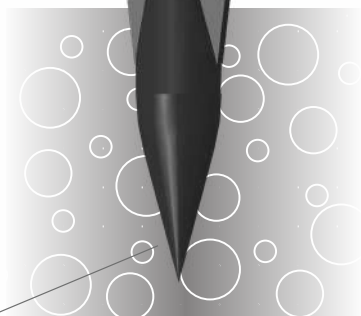

**Recommended  
length into  
the concrete**  
Min. 35 mm

**Point**  
Diamond point

## Concrete substrates

Product key	Dimensions			☒
	Ø	Screw	Thread	
DCDF-55050	5.5	50	25	1000
DCDF-55065	5.5	65	40	1000
DCDF-55075	5.5	75	50	1000
DCDF-55090	5.5	90	65	1000
DCDF-55100	5.5	100	75	1000
DCDF-55115	5.5	115	90	500
DCDF-55125	5.5	125	100	500
DCDF-55140	5.5	140	115	500
DCDF-55150	5.5	150	125	500
DCDF-55175	5.5	175	150	500
DCDF-55200	5.5	200	175	500
DCDF-55230	5.5	230	205	500
DCDF-55250	5.5	255	225	500
DCDF-55275	5.5	280	250	500
DCDF-55300	5.5	305	275	500

### Pre-drilling

Using a drill diameter Ø 6.0 mm for pre-drilling. Drilling depth: 10 mm less deep than the length of the fastener.

**Concrete substrates****EUROFAST® EF-SLAGN****STAINLESS STEEL A2**

## Concrete substrates

Product key	Clamping	Dimensions		
	mm	Ø	Hammer-drive	
EF-SLAGN4816	11.5 - 13.0	4.8	16	250
EF-SLAGN4825	20.5 - 22.0	4.8	25	250
EF-SLAGN4835	30.5 - 32.0	4.8	35	250
EF-SLAGN4850	45.5 - 47.0	4.8	50	250

### Pre-drilling

Using a drill diameter Ø 5.0 mm for pre-drilling. Drilling depth: Deeper than the length of the fastener.

# Tube washer combination for concrete substrates

## EUROFAST® TRPEAS-45

15 CYCLES KESTERNICH



Torx 25 drive  
Incl. EF-head mark

**EOTA** CE  
ETA-06/0007  
**MAGNI™**  
**SILVER**  
**POLYAMIDE PA 6**



Instructional video

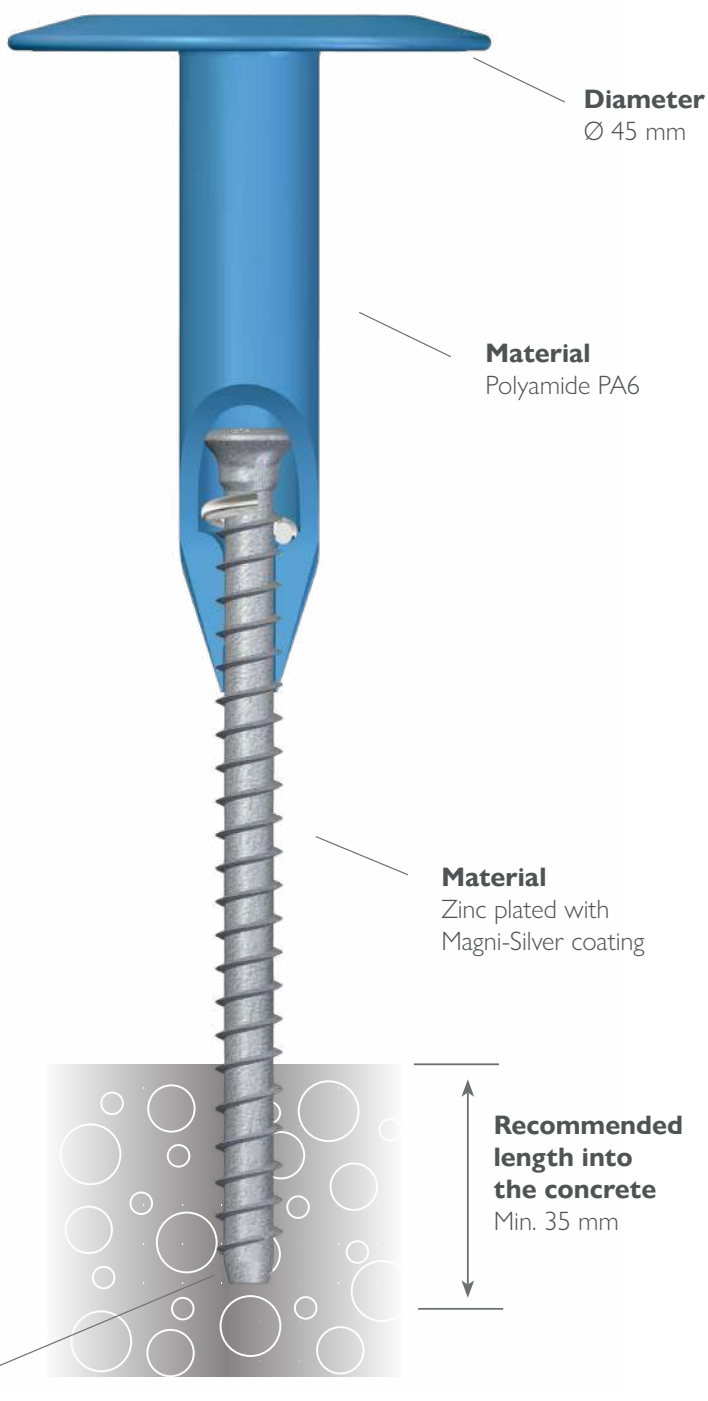

## Tube washer combination for concrete substrates

Product key	Clamping	Dimensions		✉
	mm	Tube	Screw	
TRPEAS-45-080-105	80 - 105	60	100	250
TRPEAS-45-105-165	105 - 165	90	130	250
TRPEAS-45-165-275	165 - 275	150	180	250
TRPEAS-45-245-350	245 - 350	225	180	125
TRPEAS-45-305-410	305 - 410	285	180	125

### FASTENER FOR TAPERED INSULATION



#### Pre-drilling

Using a drill diameter  $\varnothing$  5.5 mm for pre-drilling. The drilling diameter is dependent on the quality of the concrete. Drilling depth: 10 mm less deep than the length of the fastener. Drilling depth: 10 mm less deep than the length of the fastener. For instructions, scan the QR code.

# Tube washer combination for concrete substrates

## EUROFAST® BTRPEAS-45

15 CYCLES KESTERNICH



Torx 25 drive  
Incl. EF-head mark

**EOTA** CE  
ETA-06/0007  
**MAGNI™**  
**SILVER**  
**POLYAMIDE PA 6**



Instructional video

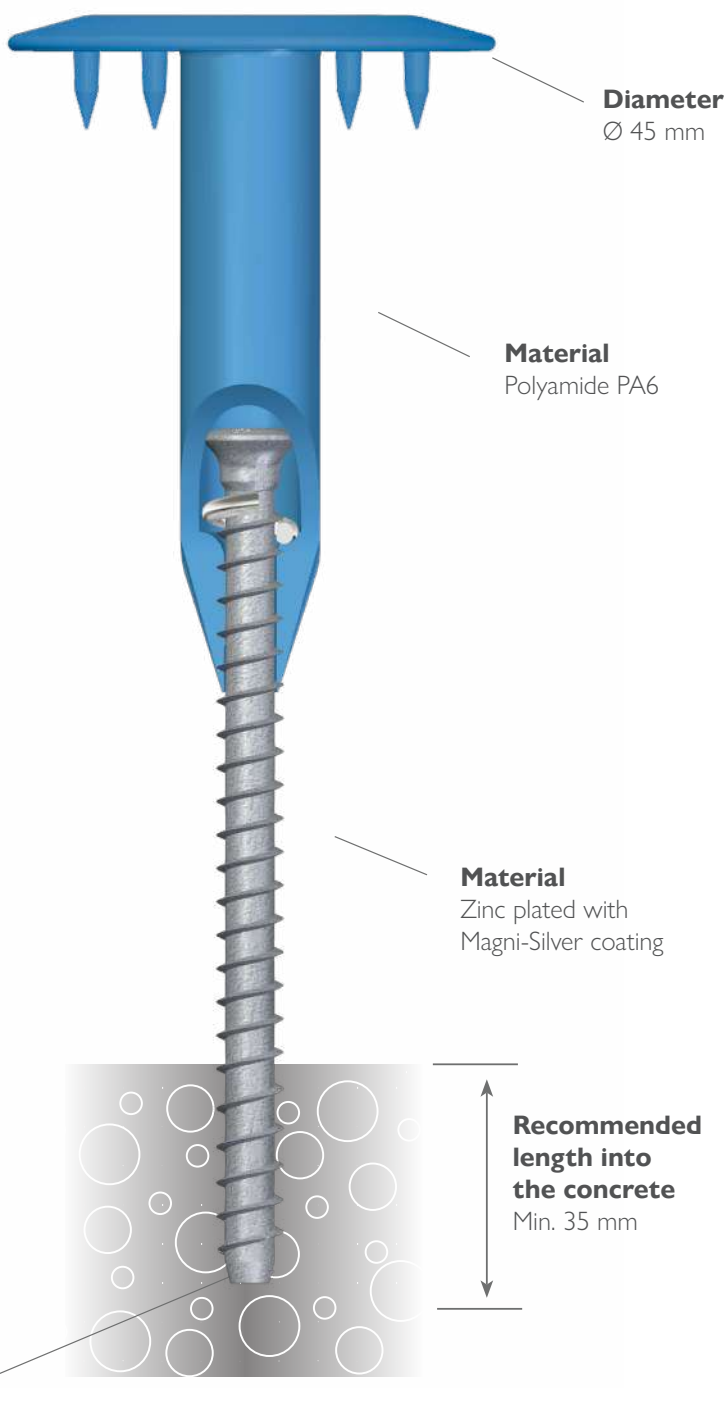



## Tube washer combination for concrete substrates

Product key	Clamping	Dimensions		✉
	mm	Tube	Screw	
BTRPEAS-45-080-105	80 - 110	60	100	250
BTRPEAS-45-105-165	110 - 165	90	130	250
BTRPEAS-45-165-275	165 - 275	150	180	250
BTRPEAS-45-245-350	245 - 350	225	180	125
BTRPEAS-45-305-410	305 - 410	285	180	125

### FASTENER FOR TAPERED INSULATION



#### Pre-drilling

Using a drill diameter  $\varnothing$  5.5 mm for pre-drilling. The drilling diameter is dependent on the quality of the concrete. Drilling depth: 10 mm less deep than the length of the fastener. Drilling depth: 10 mm less deep than the length of the fastener. For instructions, scan the QR code.

# Tube washer combination for concrete substrates

## EUROFAST® TLKEAS-45

15 CYCLES KESTERNICH



Torx 25 drive  
Incl. EF-head mark

ETA CE  
ETA-06/0007

MAGNI™  
SILVER

POLYPROPYLENE (PP)



Instructional video



**Diameter**  
Ø 45 mm

**Material**  
Polypropylene (PP)

**Material**  
Zinc plated with  
Magni-Silver coating

**Recommended  
length into  
the concrete**  
Min. 35 mm

**Point**  
Blunt point



## Tube washer combination for concrete substrates

Product key	Clamping	Dimensions		☒
	mm	Tube	Screw	
TLKEAS-45-085-110	85 - 110	65	100	250
TLKEAS-45-105-160	105 - 160	85	130	250
TLKEAS-45-155-260	155 - 260	135	180	250
TLKEAS-45-245-350	245 - 350	225	180	125
TLKEAS-45-340-445	340 - 445	320	180	125

### FASTENER FOR TAPERED INSULATION



#### Pre-drilling

Using a drill diameter  $\varnothing$  5.5 mm for pre-drilling. The drilling diameter is dependent on the quality of the concrete. Drilling depth: 10 mm less deep than the length of the fastener. Drilling depth: 10 mm less deep than the length of the fastener. For instructions, scan the QR code.

# Tube washer combination for concrete substrates

## EUROFAST® TLKEAS-75

15 CYCLES KESTERNICH



Torx 25 drive  
Incl. EF-head mark

**EOTA** CE  
ETA-06/0007

**MAGNI™**  
**SILVER**

POLYPROPYLENE (PP)



Instructional video

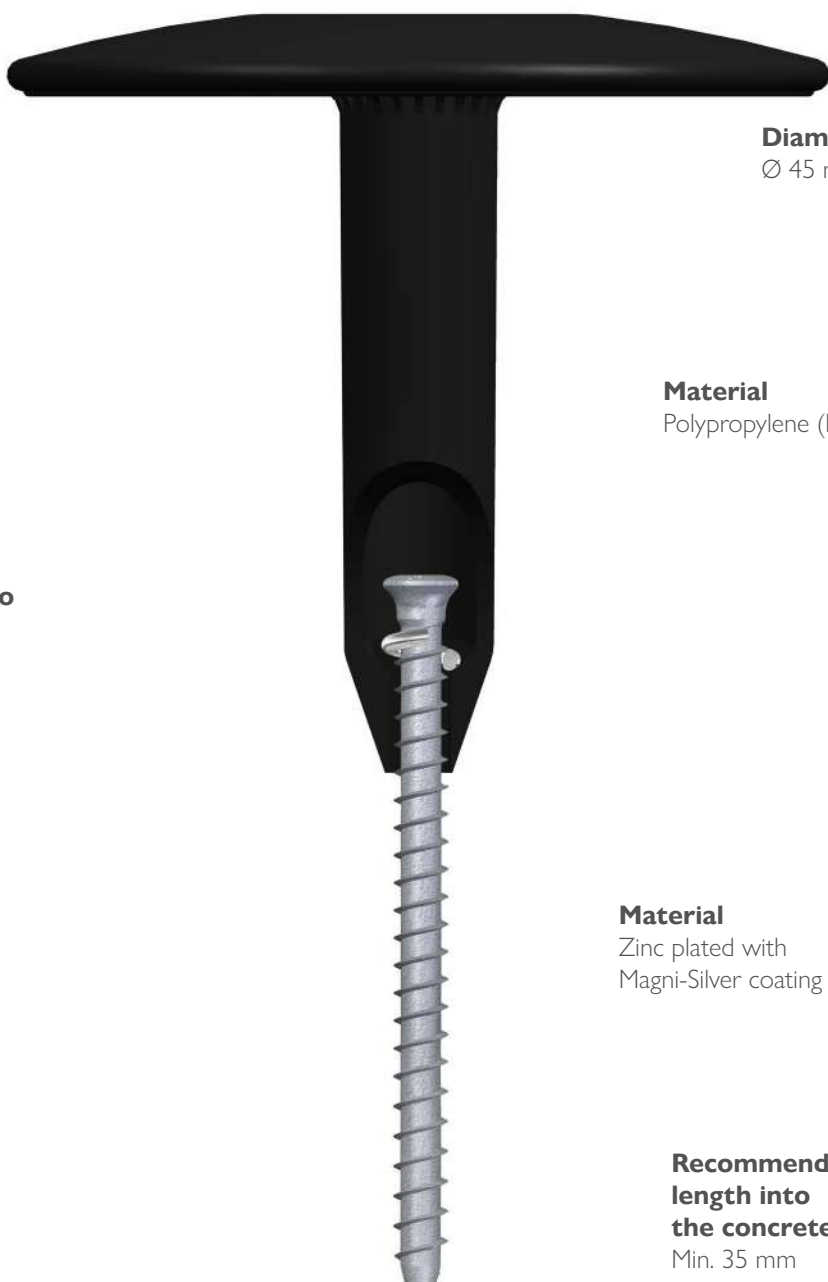

**Diameter**  
Ø 45 mm

**Material**  
Polypropylene (PP)

**Material**  
Zinc plated with  
Magni-Silver coating

**Recommended  
length into  
the concrete**  
Min. 35 mm

**Point**  
Blunt point



## Tube washer combination for concrete substrates

Product key	Clamping	Dimensions		
	mm	Tube	Screw	⊗
TLKEAS-75-085-110	85 - 110	65	100	250
TLKEAS-75-105-160	105 - 160	85	130	250
TLKEAS-75-155-210	155 - 210	135	130	125
TLKEAS-75-205-315	205 - 315	185	180	125

### FASTENER FOR TAPERED INSULATION



#### Pre-drilling

Using a drill diameter  $\varnothing$  5.5 mm for pre-drilling. The drilling diameter is dependent on the quality of the concrete. Drilling depth: 10 mm less deep than the length of the fastener. Drilling depth: 10 mm less deep than the length of the fastener. For instructions, scan the QR code.

## Tube washer combination for concrete substrates

**EUROFAST® ISPC**

15 CYCLES KESTERNICH

**Extra option**

Impact tool for upstanding  
processing of the ISPC  
ISPC-INSLAG

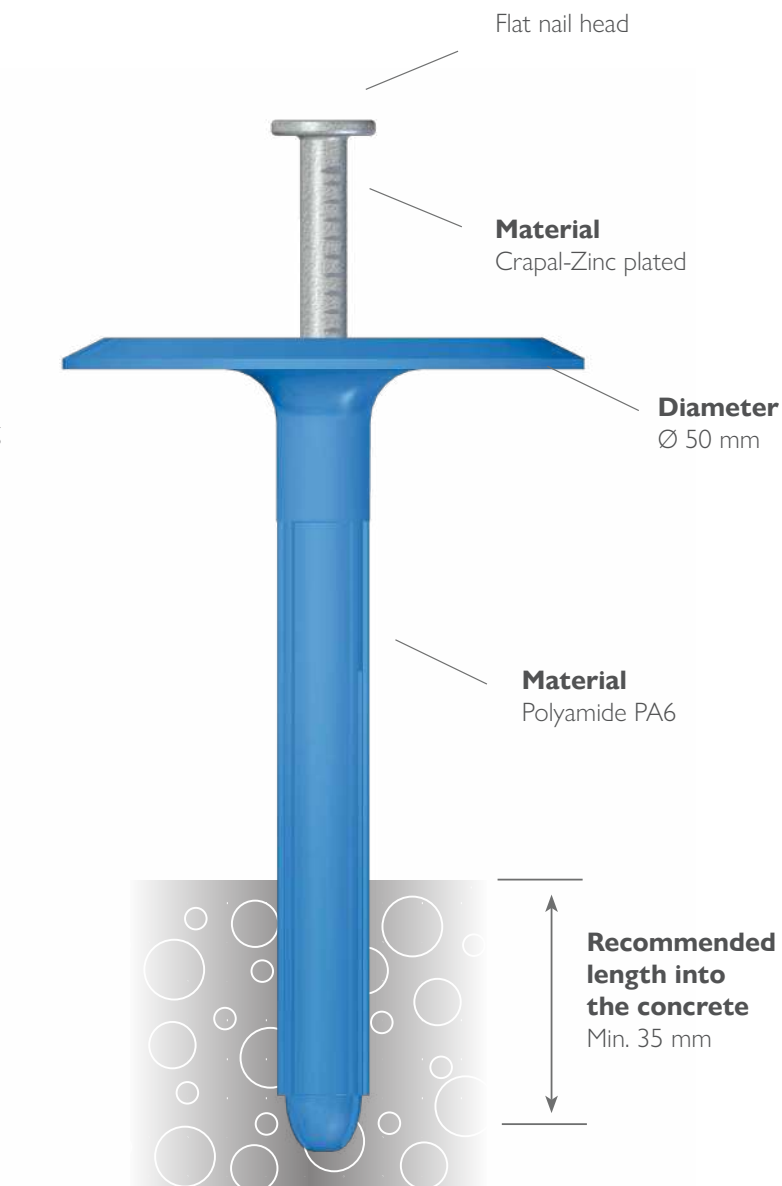

## Tube washer combination for concrete substrates

Product key	Clamping	Dimensions		
	mm	Ø	Tube	⊠
ISPC-50045	0 - 10	50	45	250
ISPC-50075	11 - 40	50	75	250
ISPC-50095	41 - 60	50	95	250
ISPC-50115	61 - 80	50	115	250
ISPC-50135	81 - 100	50	135	250
ISPC-50155	101 - 120	50	155	250
ISPC-50175	121 - 140	50	175	250
ISPC-50195	141 - 160	50	195	250
ISPC-50215	161 - 180	50	215	250
ISPC-50245	181 - 210	50	245	125
ISPC-50280	211 - 245	50	280	125
ISPC-50300	246 - 265	50	300	125
ISPC-50330	266 - 295	50	330	125
ISPC-50350	296 - 315	50	350	125
ISPC-50380	316 - 345	50	380	125
ISPC-50410	346 - 375	50	410	125

### Pre-drilling

Using a drill diameter of Ø 8.0 mm for pre-drilling. Drilling depth: A minimum of 10 mm deeper than the length of the fastener.

### Tube

The Eurofast® ISPC contains a plastic tube with a diameter of Ø 50 mm.

For fixing insulation or multiple-layered roofing membranes you need to adjust the ISPC decking plate diameter to Ø 70 mm.

### Resist foot traffic

Because of the special design of the nail and plug, the Eurofast® ISPC offers resistance to foot traffic. If installed correctly the nail won't come out of the plug.

# Tube washer combination for concrete substrates

## EUROFAST® TLKEFH-45

15 CYCLES KESTERNICH



Torx 25 drive  
Incl. EF-head mark

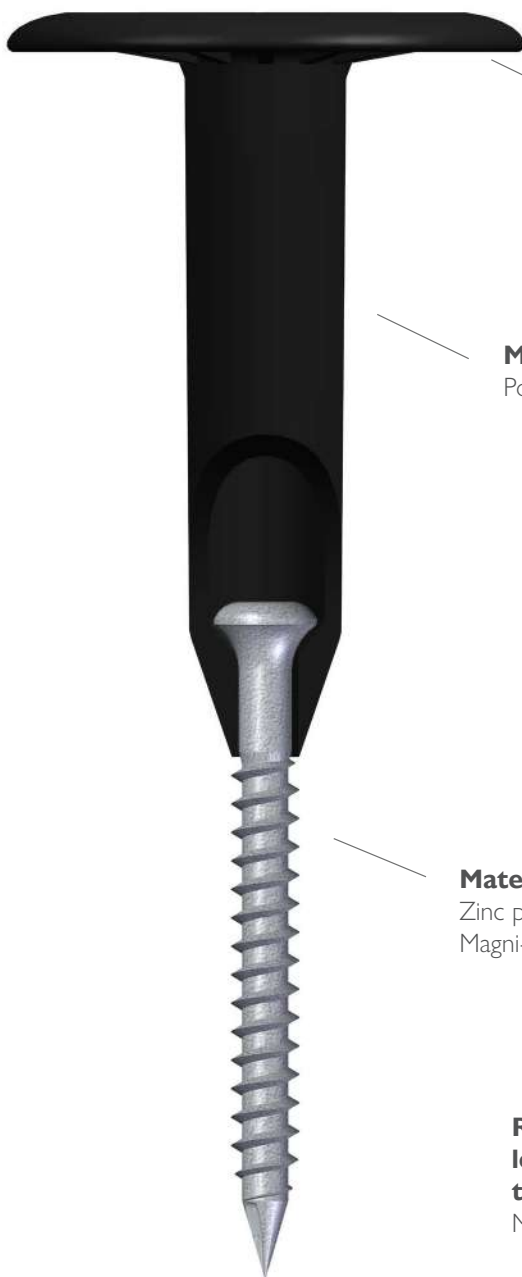

**Diameter**  
Ø 45 mm

**Material**  
Polypropylene (PP)

**Material**  
Zinc plated with  
Magni-Silver coating

**Recommended  
length into  
the concrete**  
Min. 35 mm

**Point**  
Ricoh-point



## Tube washer combination for concrete substrates

Product key	Clamping	Dimensions			✉
	mm	Tube	Screw		
* TLKEFHD-45-060	55 - 64	35	80	250	
* TLKEFHD-45-080	65 - 84	35	100	250	
* TLKEFHD-45-090	85 - 94	65	80	250	
* TLKEFHD-45-110	95 - 114	65	100	250	
* TLKEFHD-45-130	115 - 134	105	80	250	
* TLKEFHD-45-150	135 - 154	105	100	250	
* TLKEFHD-45-160	155 - 164	135	80	250	
* TLKEFHD-45-170	165 - 174	105	130	250	
* TLKEFHD-45-190	175 - 194	165	80	250	
* TLKEFHD-45-210	195 - 214	165	100	250	
* TLKEFHD-45-230	215 - 234	185	100	250	

Product key	Clamping	Dimensions			✉
	mm	Tube	Screw		
* TLKEFHD-45-250	235 - 254	225	80	125	
* TLKEFHD-45-270	255 - 274	225	100	125	
* TLKEFHD-45-300	275 - 304	255	100	125	
* TLKEFHD-45-330	305 - 334	255	130	125	
* TLKEFHD-45-360	335 - 364	285	130	125	
* TLKEFHD-45-400	365 - 404	320	130	125	
* TLKEFHD-45-430	405 - 434	320	160	125	
* TLKEFHD-45-470	435 - 474	320	200	125	
* TLKEFHD-45-520	475 - 524	320	250	125	
* TLKEFHD-45-570	525 - 574	320	300	125	

\* Delivery-time on request

### Pre-drilling

Using a drill diameter Ø 5.0, 5.2 or 5.5 mm for pre-drilling. The drilling diameter is dependent on the quality of the concrete. Drilling depth: A minimum of 10 mm deeper than the length of the fastener.

# Tube washer combination for concrete substrates

## EUROFAST® TLKEFHD-75

15 CYCLES KESTERNICH



Torx 25 drive  
Incl. EF-head mark

**ETA** CE  
ETA-06/0007

**MAGNI™**  
SILVER

POLYPROPYLENE (PP)

**FM**  
APPROVED

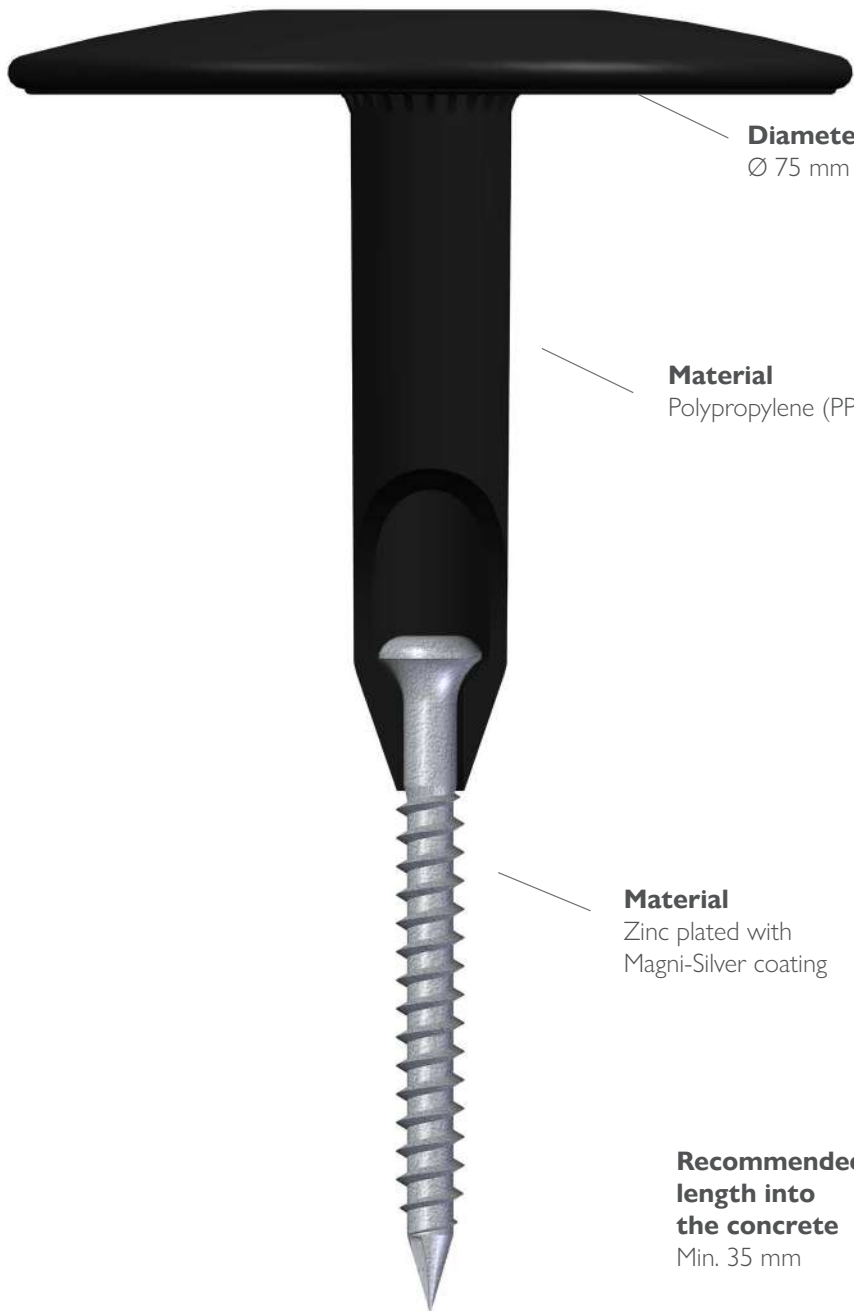

**Diameter**  
Ø 75 mm

**Material**  
Polypropylene (PP)

**Material**  
Zinc plated with  
Magni-Silver coating

**Recommended  
length into  
the concrete**  
Min. 35 mm

**Point**  
Ricoh-point

## Tube washer combination for concrete substrates

Product key	Clamping	Dimensions			✉
	mm	Tube	Screw		
* TLKEFHD-75-060	55 - 64	35	80	250	
* TLKEFHD-75-080	65 - 84	35	100	250	
* TLKEFHD-75-090	85 - 94	65	80	250	
* TLKEFHD-75-110	95 - 114	65	100	250	
* TLKEFHD-75-130	115 - 134	105	80	250	
* TLKEFHD-75-150	135 - 154	105	100	250	
* TLKEFHD-75-170	165 - 174	105	130	250	
* TLKEFHD-75-190	175 - 194	165	80	125	

Product key	Clamping	Dimensions			✉
	mm	Tube	Screw		
* TLKEFHD-75-210	195 - 214	165	100	125	
* TLKEFHD-75-230	215 - 234	185	100	125	
* TLKEFHD-75-260	235 - 264	185	130	125	
* TLKEFHD-75-290	265 - 294	185	160	125	
* TLKEFHD-75-330	295 - 334	185	200	125	
* TLKEFHD-75-380	335 - 384	185	250	125	
* TLKEFHD-75-430	385 - 434	185	300	125	

\* Delivery-time on request

### Pre-drilling

Using a drill diameter Ø 5.0, 5.2 or 5.5 mm for pre-drilling. The drilling diameter is dependent on the quality of the concrete. Drilling depth: A minimum of 10 mm deeper than the length of the fastener.

# Tube washer combination for concrete substrates

## EUROFAST® TLKEFR-45

15 CYCLES KESTERNICH



Torx 25 drive  
Incl. EF-head mark

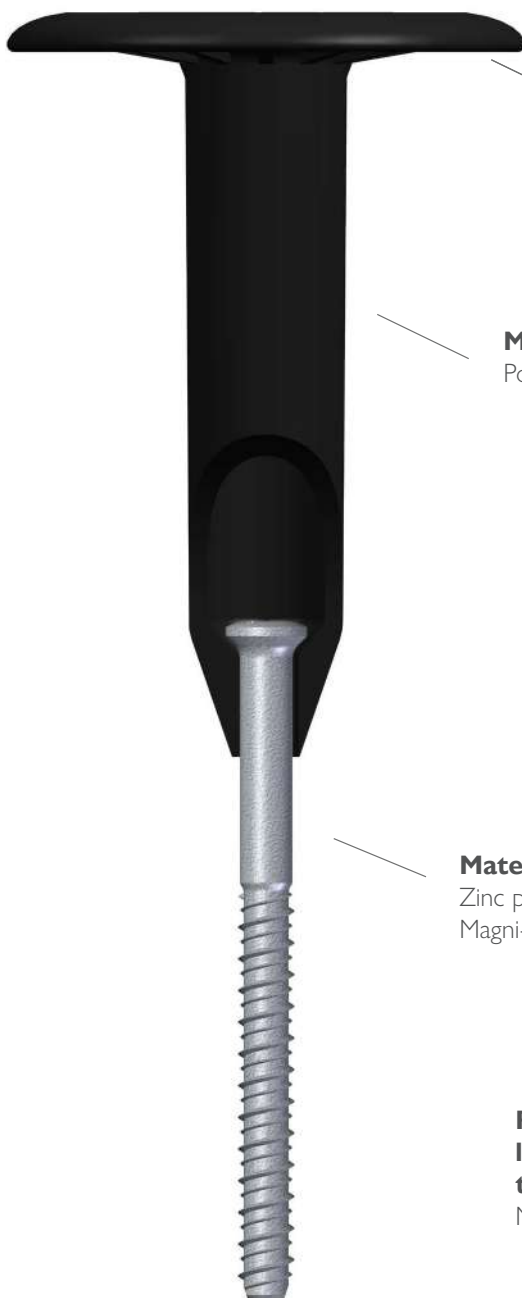

**Diameter**  
Ø 45 mm

**Material**  
Polypropylene (PP)

**Material**  
Zinc plated with  
Magni-Silver coating

**Recommended  
length into  
the concrete**  
Min. 35 mm

**Point**  
Blunt point

## Tube washer combination for concrete substrates

Product key	Clamping	Dimensions		
	mm	Tube	Screw	⊠
* TLKEFR-45-060	55 - 64	35	75	250
* TLKEFR-45-070	65 - 74	35	85	250
* TLKEFR-45-080	75 - 84	35	95	250
* TLKEFR-45-090	85 - 94	65	75	250
* TLKEFR-45-100	95 - 104	65	85	250
* TLKEFR-45-110	105 - 114	65	95	250
* TLKEFR-45-120	115 - 124	85	85	250
* TLKEFR-45-130	125 - 134	85	95	250
* TLKEFR-45-140	135 - 144	105	85	250
* TLKEFR-45-150	145 - 154	105	95	250
* TLKEFR-45-160	155 - 164	135	75	250
* TLKEFR-45-170	165 - 174	135	85	250

Product key	Clamping	Dimensions		
	mm	Tube	Screw	⊠
* TLKEFR-45-180	175 - 184	135	95	250
* TLKEFR-45-190	185 - 194	165	75	250
* TLKEFR-45-200	195 - 204	165	85	250
* TLKEFR-45-210	205 - 214	165	95	250
* TLKEFR-45-220	215 - 224	185	85	250
* TLKEFR-45-230	225 - 234	185	95	250
* TLKEFR-45-255	235 - 259	185	120	250
* TLKEFR-45-275	260 - 279	185	140	250
* TLKEFR-45-295	280 - 299	185	160	250
* TLKEFR-45-315	300 - 319	185	180	250
* TLKEFR-45-335	320 - 339	185	200	250

\* Delivery-time on request

### Pre-drilling

Using a drill diameter Ø 5.0, 5.2 or 5.5 mm for pre-drilling. The drilling diameter is dependent on the quality of the concrete. Drilling depth: A minimum of 10 mm deeper than the length of the fastener.

# Tube washer combination for concrete substrates

## EUROFAST® TLKEFR-75

15 CYCLES KESTERNICH



Torx 25 drive  
Incl. EF-head mark

**EOTA** CE  
ETA-06/0007  
**MAGNI™**  
**SILVER**  
POLYPROPYLENE (PP)

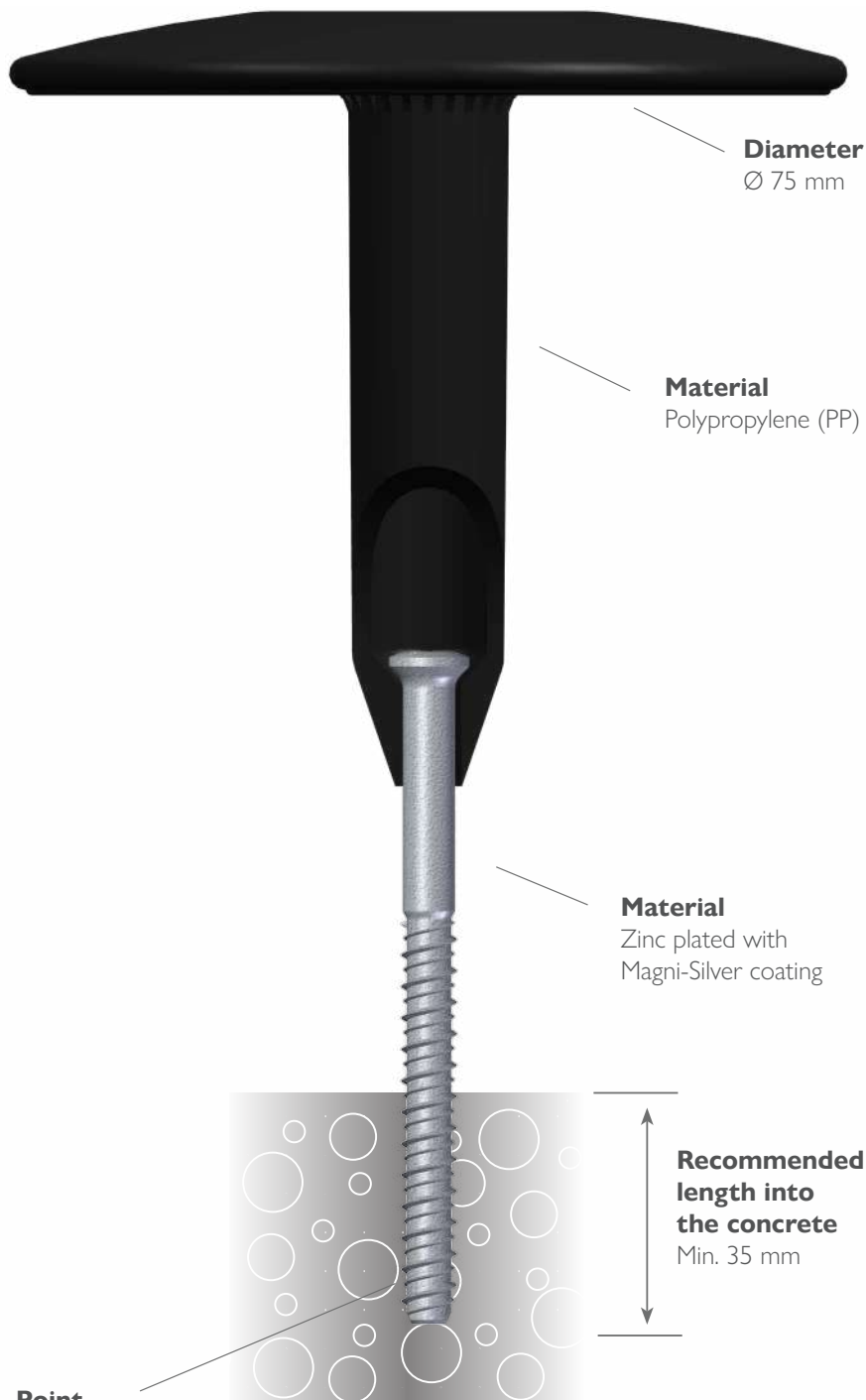

**Diameter**  
Ø 75 mm

**Material**  
Polypropylene (PP)

**Material**  
Zinc plated with  
Magni-Silver coating

**Recommended  
length into  
the concrete**  
Min. 35 mm

**Point**  
Blunt point

## Tube washer combination for concrete substrates

Product key	Clamping	Dimensions		
	mm	Tube	Screw	⊠
* TLKEFR-75-060	55 - 64	35	75	250
* TLKEFR-75-070	65 - 74	35	85	250
* TLKEFR-75-080	75 - 84	35	95	250
* TLKEFR-75-090	85 - 94	65	75	250
* TLKEFR-75-100	95 - 104	65	85	250
* TLKEFR-75-110	105 - 114	65	95	250
* TLKEFR-75-120	115 - 124	85	85	250
* TLKEFR-75-130	125 - 134	85	95	250
* TLKEFR-75-140	135 - 144	105	85	250
* TLKEFR-75-150	145 - 154	105	95	250
* TLKEFR-75-160	155 - 164	135	75	250
* TLKEFR-75-170	165 - 174	135	85	250

Product key	Clamping	Dimensions		
	mm	Tube	Screw	⊠
* TLKEFR-75-180	175 - 184	135	95	250
* TLKEFR-75-190	185 - 194	165	75	250
* TLKEFR-75-200	195 - 204	165	85	250
* TLKEFR-75-210	205 - 214	165	95	250
* TLKEFR-75-220	215 - 224	185	85	250
* TLKEFR-75-230	225 - 234	185	95	250
* TLKEFR-75-255	235 - 259	185	120	250
* TLKEFR-75-275	260 - 279	185	140	250
* TLKEFR-75-295	280 - 299	185	160	250
* TLKEFR-75-315	300 - 319	185	180	250
* TLKEFR-75-335	320 - 339	185	200	250

\* Delivery-time on request

### Pre-drilling

Using a drill diameter Ø 5.0, 5.2 or 5.5 mm for pre-drilling. The drilling diameter is dependent on the quality of the concrete. Drilling depth: A minimum of 10 mm deeper than the length of the fastener.

## Tube washer combination for concrete substrates

**EUROFAST® ISPC-A2****STAINLESS STEEL A2****Extra option**

Impact tool for upstanding  
processing of the ISPC  
ISPC-INSLAG

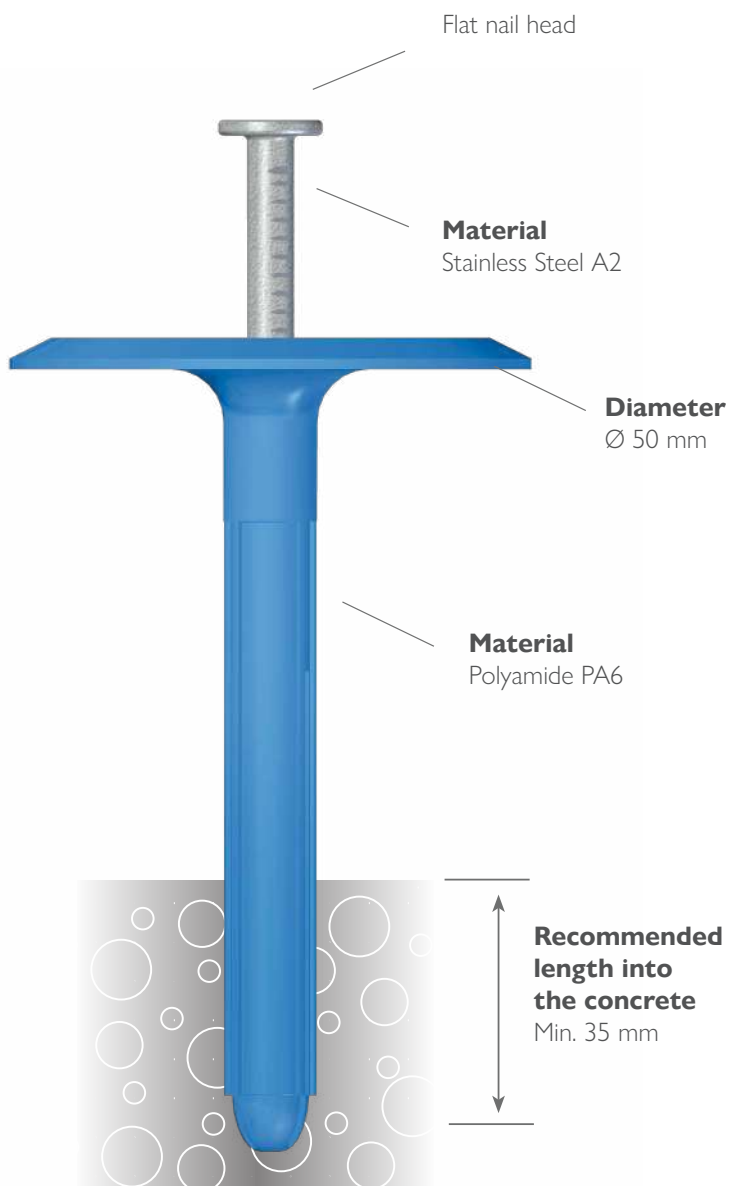



## Tube washer combination for concrete substrates

Product key	Clamping	Dimensions		
	mm	Ø	Tube	⊠
ISPC-A2-50045	0 - 10	50	45	250
ISPC-A2-50075	11 - 40	50	75	250
ISPC-A2-50095	41 - 60	50	95	250
ISPC-A2-50115	61 - 80	50	115	250
ISPC-A2-50135	81 - 100	50	135	250
ISPC-A2-50155	101 - 120	50	155	250
ISPC-A2-50175	121 - 140	50	175	250
ISPC-A2-50195	141 - 160	50	195	250
ISPC-A2-50215	161 - 180	50	215	250
ISPC-A2-50245	181 - 210	50	245	125
ISPC-A2-50280	211 - 245	50	280	125
ISPC-A2-50300	246 - 265	50	300	125
ISPC-A2-50330	266 - 295	50	330	125
ISPC-A2-50350	296 - 315	50	350	125
ISPC-A2-50380	316 - 345	50	380	125
ISPC-A2-50410	346 - 375	50	410	125

### Pre-drilling

Using a drill diameter of Ø 8.0 mm for pre-drilling. Drilling depth: A minimum of 10 mm deeper than the length of the fastener.

### Tube

The Eurofast® ISPC contains a plastic tube with a diameter of Ø 50 mm.

For fixing insulation or multiple-layered roofing membranes you need to adjust the ISPC decking plate diameter to Ø 70 mm.

### Resist foot traffic

Because of the special design of the nail and plug, the Eurofast® ISPC offers resistance to foot traffic. If installed correctly the nail won't come out of the plug.

## Roofing fasteners for cementitious wood fibre substrates

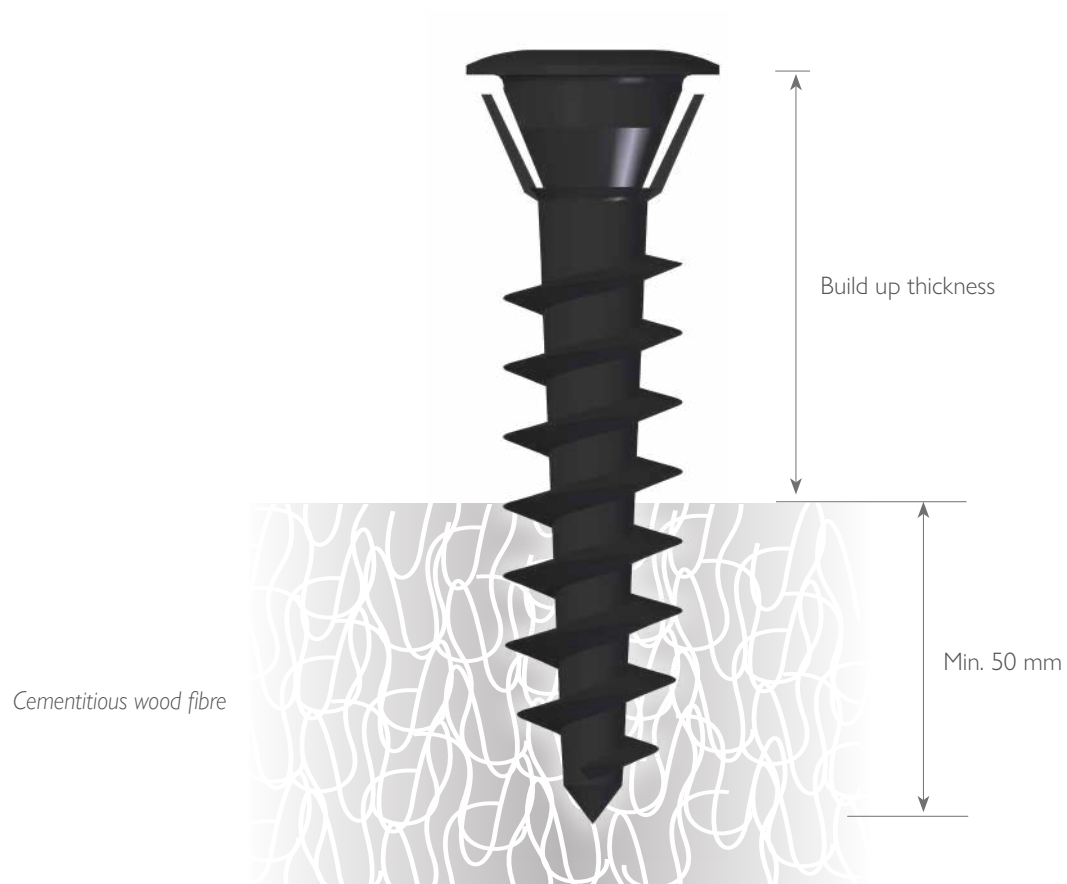

## Roofing fasteners for cementitious wood fibre substrates

### Plastic



### Cementitious wood fibre

For mechanical fixing onto cementitious wood fibre, we always advise to perform a pull-out test on site. To request for a pull out test at site or for more information, please contact us

+31 493 31 58 85 or by email [sales@eurofastgroup.com](mailto:sales@eurofastgroup.com)

## Cementitious wood fibre substrates

# OMG GYPTEC - GDL

PLASTIC



Robertson driver  
Incl. EF-head mark

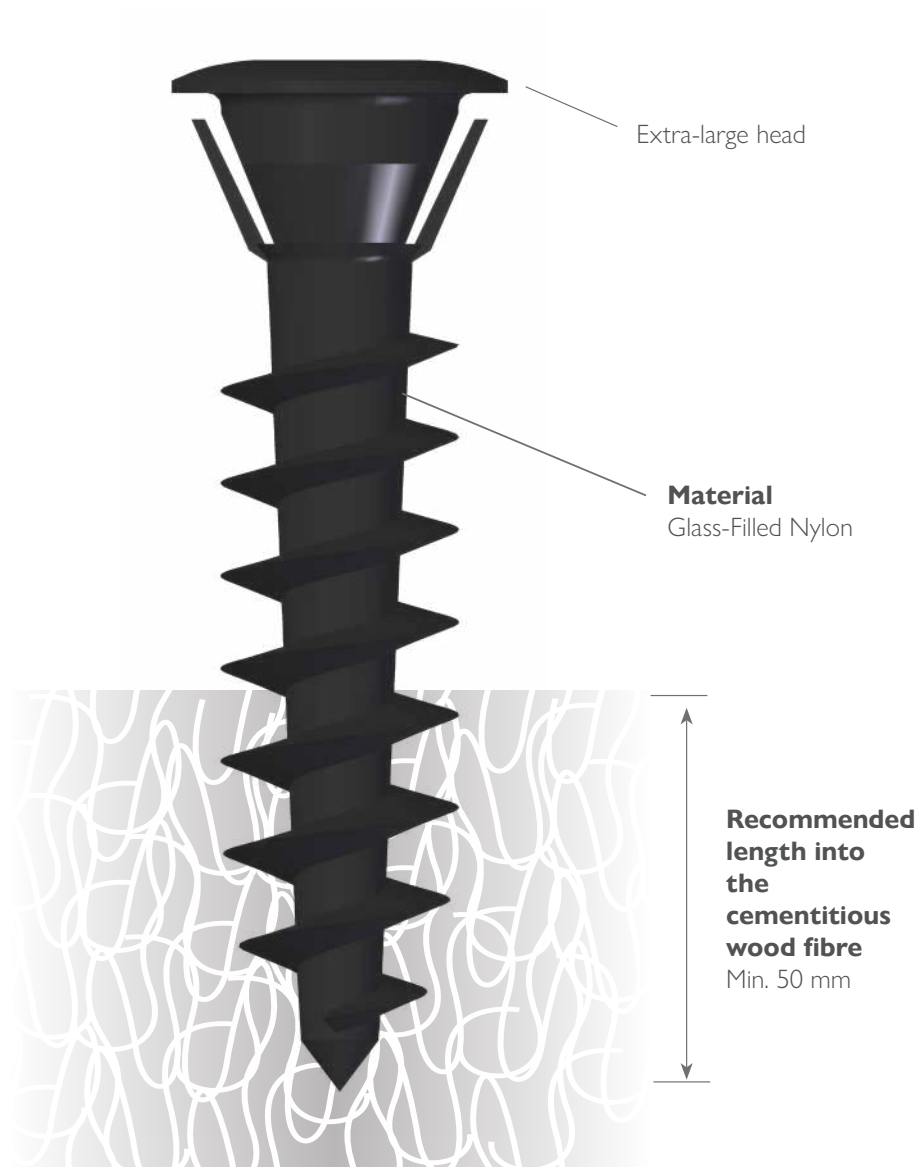

## Cementitious wood fibre substrates

Product key	Dimensions			
	Ø	Screw	Thread	⊠
GDL-18063	18	60	38	500
GDL-18076	18	75	57	500
GDL-18102	18	100	57	500
GDL-18127	18	125	57	500
GDL-18152	18	150	57	500
GDL-18178	18	175	57	500
GDL-18203	18	200	57	250

### Driver bit

Included  
OND-TB-GDL



### Cementitious wood fibre

For mechanical fixing onto cementitious wood fibre, we always advise to perform a pull-out test on site. To request for a pull out test at site or for more information, please contact us

+31 493 31 58 85 or by email [sales@eurofastgroup.com](mailto:sales@eurofastgroup.com)

## Tube washers and pressure plates

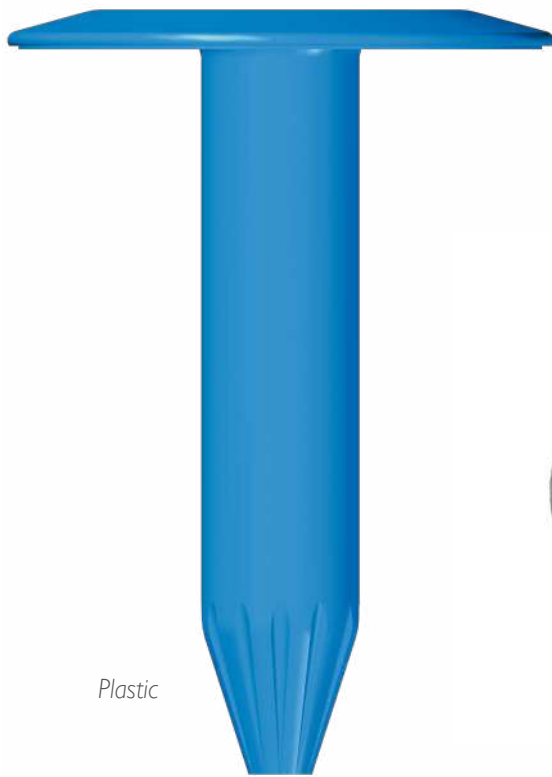

*Plastic*

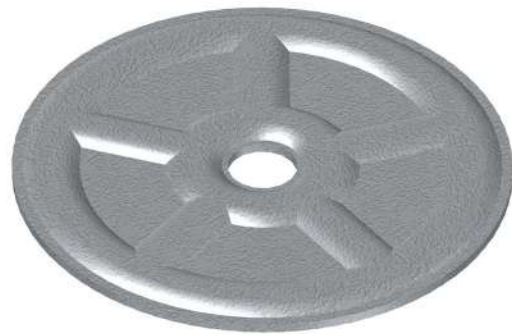

*Metal*

# Tube washers and pressure plates

## Tube for single layered roofing membranes - Plastic

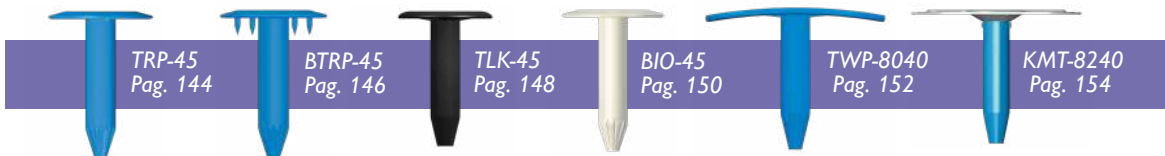

## Pressure plate for single layered roofing membranes - 15 cycles Kesternich



## Tube for insulation and multiple layered roofing membranes - Plastic



## Pressure plate for insulation and multiple layered roofing membranes - 15 cycles Kesternich



## Pressure plate for machine processing - 15 cycles Kesternich



Tube for single layered roofing membranes

# EUROFAST® TRP-45

PLASTIC



**Diameter**  
Ø 45 mm

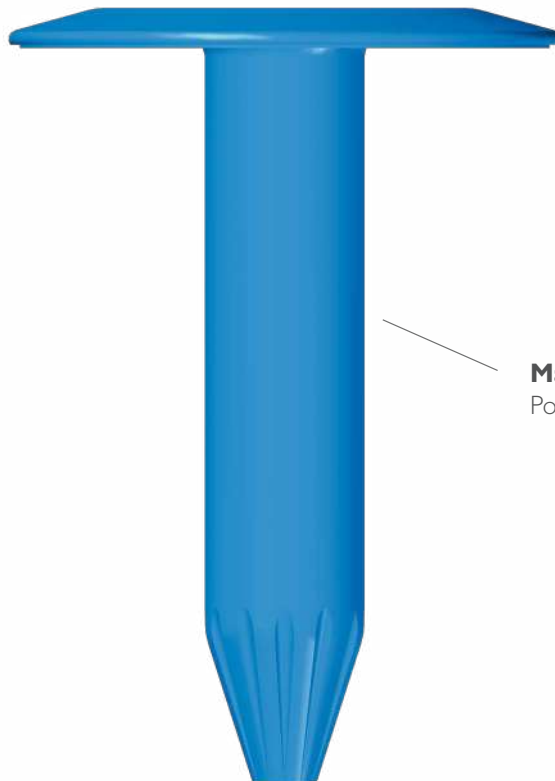

**Material**  
Polyamide PA6



## Tube for single layered roofing membranes

Product key	Dimensions			☒
	Ø	Tube		
TRP-45-L030-250	45	30		250
TRP-45-L060-250	45	60		250
TRP-45-L090-250	45	90		250
TRP-45-L120-250	45	120		250
TRP-45-L135-250	45	135		250
TRP-45-L150-250	45	150		250
TRP-45-L225-125	45	225		125
TRP-45-L285-125	45	285		125

Tube for single layered roofing membranes

# EUROFAST® BTRP-45

PLASTIC



Diameter  
Ø 45 mm

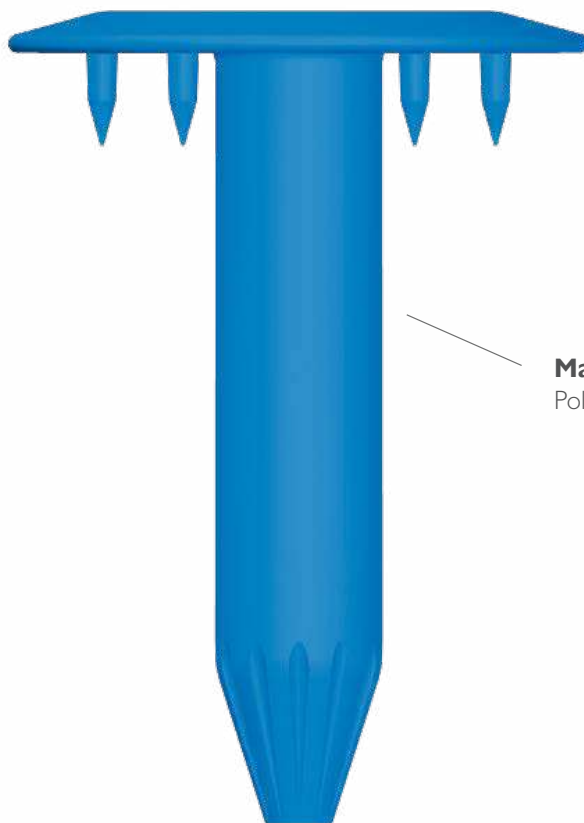

Material  
Polyamide PA6

## Tube for single layered roofing membranes

Product key	Dimensions			☒
	Ø	Tube		
BTRP-45-L030-250	45	30		250
BTRP-45-L060-250	45	60		250
BTRP-45-L090-250	45	90		250
BTRP-45-L120-250	45	120		250
BTRP-45-L135-250	45	135		250
BTRP-45-L150-250	45	150		250
* BTRP-45-L225-250	45	225		250
* BTRP-45-L285-250	45	280		250

\* Delivery-time on request

## Tube for single layered roofing membranes

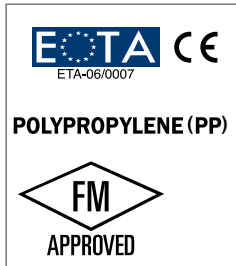
**EUROFAST® TLK-45****PLASTIC**

**Diameter**  
Ø 45 mm



**Material**  
Polypropylene (PP)

## Tube for single layered roofing membranes

Product key	Dimensions			☒
	Ø	Tube		
TLK-45020	45	20		500
TLK-45035	45	35		500
TLK-45065	45	65		500
TLK-45085	45	85		500
TLK-45105	45	105		500
TLK-45135	45	135		250
TLK-45165	45	165		250
TLK-45185	45	185		250
TLK-45225	45	225		125
TLK-45255	45	255		125
TLK-45285	45	285		125
TLK-45320	45	320		125

Tube for single layered roofing membranes

# EUROFAST® BIO-45

PLASTIC



**Diameter**  
Ø 45 mm

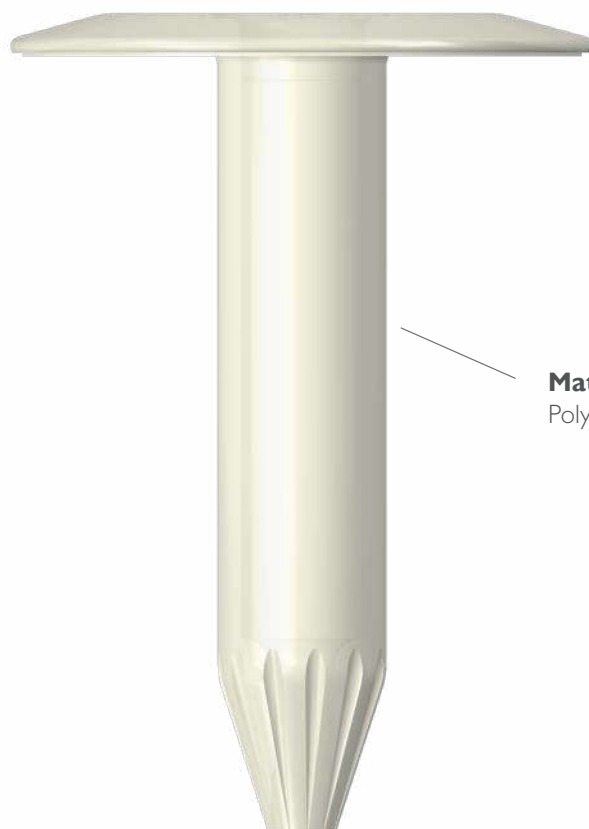

**Material**  
Polyamide PA410

## Tube for single layered roofing membranes

Product key	Dimensions		
	Ø	Tube	⊠
BIO-45-L060-250	45	60	250
BIO-45-L090-250	45	90	250
BIO-45-L120-250	45	120	250

### Bio tube

The Eurofast® Bio tube is made of a biobased material which can be recycled in combination with the membrane. For more information, please contact us

+31 493 31 58 85 or by email [sales@eurofastgroup.com](mailto:sales@eurofastgroup.com)

Tube for single layered roofing membranes

# EUROFAST® TWP-8040

PLASTIC



**Dimension**  
80 x 40 mm

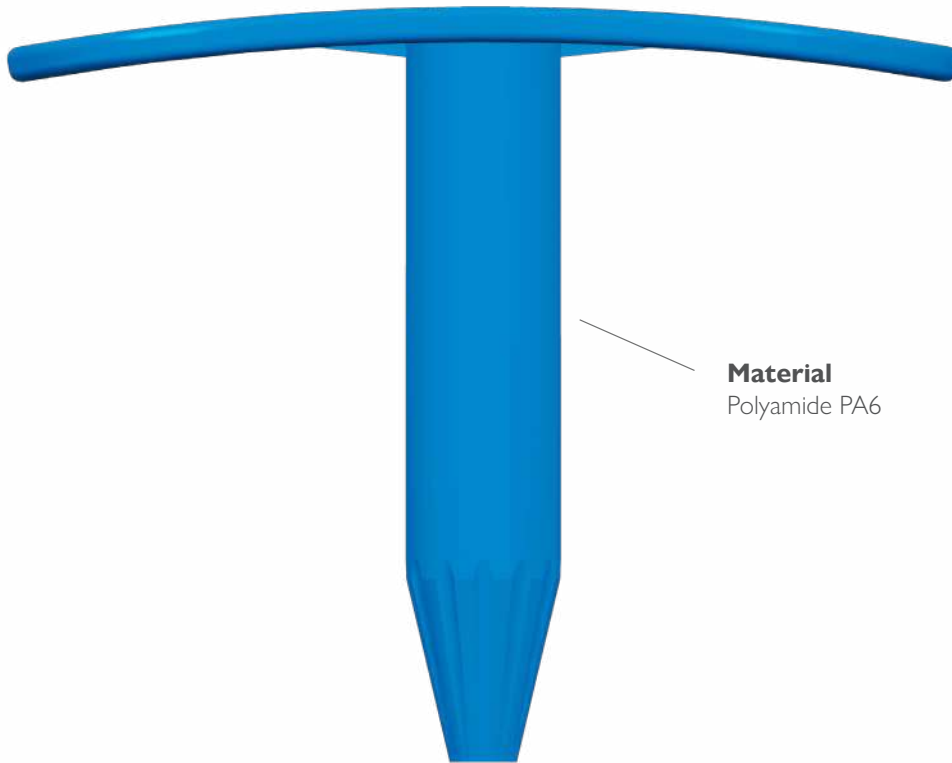

**Material**  
Polyamide PA6



## Tube for single layered roofing membranes

Product key	Dimensions			⊠
	Ø	Tube		
TWP-8040L030-250	80 x 40	30		250
TWP-8040L060-250	80 x 40	60		250
TWP-8040L090-250	80 x 40	90		250
TWP-8040L120-250	80 x 40	120		250
TWP-8040L150-250	80 x 40	150		250

## Tube for single layered roofing membranes

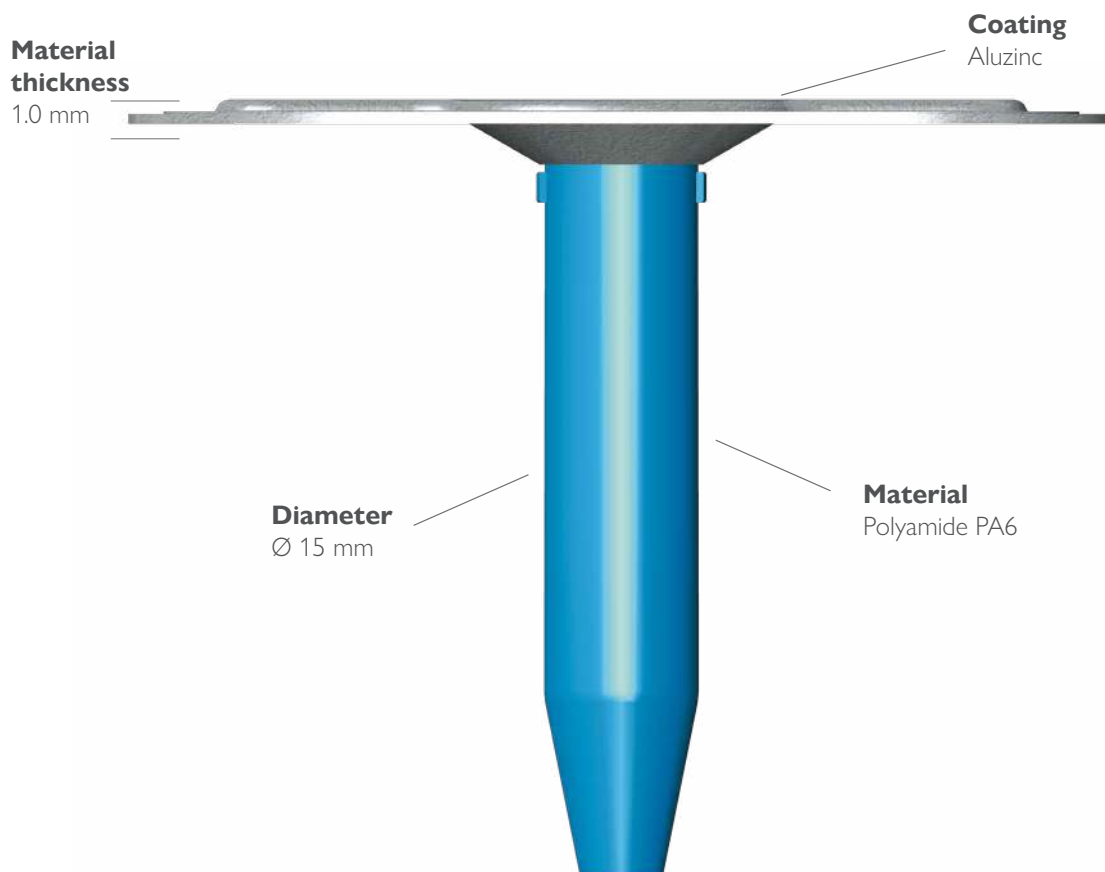
**EUROFAST® KMT-8240****PLASTIC**  
**15 CYCLES KESTERNICH****Dimension pressure plate**  
82 x 40 mm

## Tube for single layered roofing membranes

Product key	Dimensions			
	Ø DVP	Ø Tube	Tube	⊠
KMT-15035D82	82 x 40	15	35	250
KMT-15085D82	82 x 40	15	85	250
KMT-15135D82	82 x 40	15	135	250
KMT-15185D82	82 x 40	15	185	250
KMT-15255D82	82 x 40	15	255	250
KMT-15285D82	82 x 40	15	285	250
KMT-15320D82	82 x 40	15	320	250

## Pressure plate for single layered roofing membranes

# EUROFAST® DVP

## 15 CYCLES KESTERNICH

Aluzinc

**S** Soft insulation

**H** Hard insulation

**N** No insulation



**H**

Certification	DVP-EF-5010N	☒
 ETA-06/0007 	Dimension	Ø 50 mm
	Hole	Ø 6.3 mm
	Material thickness	1.0 mm
		1000 pcs



**S**

Certification	DVP-EF-5010D	☒
 ETA-06/0007 	Dimension	Ø 50 mm
	Hole	Ø 6.3 mm
	Material thickness	1.0 mm
		1000 pcs



**N**

Certification	DVP-EF-51N	☒
 ETA-06/0007 	Dimension	Ø 51 mm
	Hole	Ø 6.7 mm
	Material thickness	0.84 mm
		1000 pcs



**N**

Certification	DVP-DF-51N	☒
 ETA-09/0337 	Dimension	Ø 51 mm
	Hole	Ø 6.7 mm
	Material thickness	0.7 mm
		1000 pcs



**H**

Certification	DVP-EFB-51NS	☒
 ETA-06/0007 	Dimension	Ø 51 mm
	Hole	Ø 5.4 mm
	Material thickness	0.84 mm
		1000 pcs



**H**

Certification	DVP-DFB-51N	☒
 ETA-09/0337 	Dimension	Ø 51 mm
	Hole	Ø 6.7 mm
	Material thickness	0.7 mm
		1000 pcs



Certification	DVP-GDL-51N	☒
 ETA-09/0337 	Dimension	Ø 51 mm
	Hole	Ø 18 mm
	Material thickness	0.7 mm
		500 pcs

# Pressure plate for single layered roofing membranes

## 15 CYCLES KESTERNICH

**Aluzinc**

**S** Soft insulation

**H** Hard insulation

**N** No insulation



**H**

Certification	DVP-EF-8040N	☒
 ETA-06/0007 	Dimension	80 x 40 mm
	Hole	Ø 6.5 mm
	Material thickness	1.0 mm
		500 pcs



**S**

Certification	DVP-EF-8040D	☒
 ETA-06/0007 	Dimension	80 x 40 mm
	Hole	Ø 6.5 mm
	Material thickness	1.0 mm
		500 pcs



**S**

Certification	DVP-DF-8240D	☒
 ETA-06/0007 	Dimension	82 x 40 mm
	Hole	Ø 7.0 mm
	Material thickness	1.0 mm
		100 pcs



**S**

Certification	DVP-DF-8240R	☒
 ETA-06/0007 	Dimension	82 x 40 mm
	Hole	Ø 7.0 mm
	Material thickness	1.0 mm
		100 pcs



**S**

Certification	DVP-DFB8240D	☒
 ETA-06/0007 	Dimension	82 x 40 mm
	Hole	Ø 7.0 mm
	Material thickness	1.0 mm
		700 pcs



**N**

Certification	DVP-DF-8240H	☒
 ETA-06/0007 	Dimension	82 x 40 mm
	Hole	Ø 7.0 mm
	Material thickness	1.0 mm
		80 pcs



**N**

Certification	DVP-DF8240XH	☒
 ETA-06/0007 	Dimension	82 x 40 mm
	Hole	Ø 7.0 mm
	Material thickness	1.0 mm
		90 pcs



**N**

Certification	DVP-EF8240XH	☒
 ETA-06/0007 	Dimension	82 x 40 mm
	Hole	Ø 4.85 mm
	Material thickness	1.0 mm
		90 pcs

# Pressure plate for single layered roofing membranes

## 15 CYCLES KESTERNICH

**Aluzinc**

**S** Soft insulation

**H** Hard insulation

**N** No insulation



**H**

Certification	DVP-EF-8040N-9	✉
 ETA-06/0007 	Dimension	80 x 40 mm
	Hole	Ø 9.0 mm
	Material thickness	1.0 mm
		500 pcs



Certification	EDF-BAR-F of FB	✉
 ETA-06/0007 	Dimension	2250 x 30 mm
	Hole	Ø 4.85 / 8.0 mm
	Material thickness	1.0 mm
		10 pcs

PLASTIC			
			<b>S</b>
Certification	DVP-DFK-51N	✉	
 ETA-09/0337 	Dimension	Ø 50 mm	
	Hole	Ø 6.8 mm - Tri-lock	
	Material thickness	1.2 mm - Nylon	
			1000 pcs

			<b>N</b>
Certification	DVP-EF-4010N	✉	
 ETA-06/0007 	Dimension	Ø 40 mm	
	Hole	Ø 6.0 mm	
	Material thickness	1.0 mm	
			1000 pcs



Tube for insulation and multiple layered roofing membranes

# EUROFAST® TLK-75

PLASTIC



Diameter  
Ø 75 mm



Material  
Polypropylene (PP)



## Tube for insulation and multiple layered roofing membranes

Product key	Dimensions			☒
	Ø	Tube		
TLK-75035	75	35		250
TLK-75065	75	65		250
TLK-75085	75	85		250
TLK-75105	75	105		250
TLK-75135	75	135		250
TLK-75165	75	165		250
TLK-75185	75	185		250

## Pressure plate for insulation and multiple layered roofing membranes

# EUROFAST® DVP

## 15 CYCLES KESTERNICH

Aluzinc

**S** Soft insulation

**H** Hard insulation

**N** No insulation



**H**

Certification	DVP-EF-7005N	☒
 ETA-06/0007 	Dimension	Ø 70 mm
	Hole	Ø 5.1 mm
	Material thickness	0.5 mm
		1000 pcs



**H**

Certification	DVP-EF7005N5	☒
 ETA-06/0007 	Dimension	Ø 70 mm
	Hole	Ø 5.1 mm
	Material thickness	0.5 mm
		500 pcs



**S**

Certification	DVP-EF-7005D	☒
 ETA-06/0007 	Dimension	Ø 70 mm
	Hole	Ø 5.0 mm
	Material thickness	0.5 mm
		1000 pcs



**H**

Certification	DVP-EF-7007N	☒
 ETA-06/0007 	Dimension	Ø 70 mm
	Hole	Ø 6.0 mm
	Material thickness	0.7 mm
		1000 pcs



**H**

Certification	DVP-EF7007N5	☒
 ETA-06/0007 	Dimension	Ø 70 mm
	Hole	Ø 6.0 mm
	Material thickness	0.7 mm
		500 pcs



**N**

Certification	DVP-EF-7007D	☒
 ETA-06/0007 	Dimension	Ø 70 mm
	Hole	Ø 6.0 mm
	Material thickness	0.7 mm
		500 pcs



**N**

Certification	DVP-EF-7007H	☒
 ETA-06/0007 	Dimension	Ø 70 mm
	Hole	Ø 6.0 mm
	Material thickness	0.7 mm
		500 pcs

# Pressure plate for insulation and multiple layered roofing membranes

## 15 CYCLES KESTERNICH

**Aluzinc**

**S** Soft insulation

**H** Hard insulation

**N** No insulation

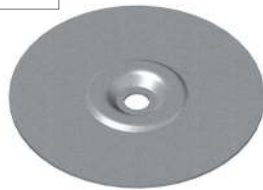

**H**

Certification	DVP-EF-7010N	☒
 ETA-06/0007 	Dimension	Ø 70 mm
	Hole	Ø 6.5 mm
	Material thickness	1.0 mm
		500 pcs



**Z**

Certification	DVP-EF-7010D	☒
 ETA-06/0007 	Dimension	Ø 70 mm
	Hole	Ø 6.5 mm
	Material thickness	1.0 mm
		500 pcs



Certification	DVP-DF-73N	☒
 ETA-09/0337 	Dimension	Ø 73 mm
	Hole	Ø 6.5 mm
	Material thickness	0.7 mm
		1000 pcs



Certification	DVP-GDL-73N	☒
 ETA-09/0337 	Dimension	Ø 73 mm
	Hole	Ø 18 mm
	Material thickness	0.7 mm
		500 pcs



Certification	DVP-ISPC-70N	☒
 ETA-06/0007 	Dimension	Ø 70 mm
	Hole	Ø 12 mm
	Material thickness	0.5 mm
		250 pcs

PLASTIC		
		<b>S</b>
Certification	DVP-DFK-73N	☒
 ETA-09/0337 	Dimension	Ø 75 mm
	Hole	Ø 6.8 mm - Tri-lock
	Material thickness	1.2 mm - Polypropylene (PP)
		1000 pcs

## Pressure plate for machine processing membranes

# EUROFAST® DVP

### 15 CYCLES KESTERNICH

Aluzinc

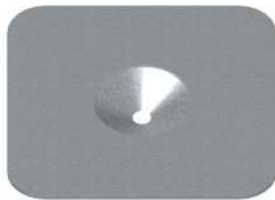

Certification	DVP-EF-7070D		☒
<b>ETA</b> ETA-06/0007 <b>CE</b>	Dimension	70 x 70 mm	100 pcs
	Hole	Ø 4.85 mm	
	Material thickness	1.0 mm	



Certification	DVP-EF-8240D		☒
<b>ETA</b> ETA-06/0007 <b>CE</b>	Dimension	82 x 40 mm	100 pcs
	Hole	Ø 4.85 mm	
	Material thickness	1.0 mm	

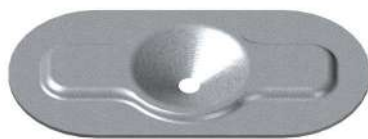

Certification	DVPEFZK8240D		☒
<b>ETA</b> ETA-06/0007 <b>CE</b> <b>FM</b> APPROVED	Dimension	82 x 40 mm	90 pcs
	Hole	Ø 4.85 mm	
	Material thickness	1.0 mm	



Certification	DVP-EFB8240D		☒
<b>ETA</b> ETA-06/0007 <b>CE</b>	Dimension	82 x 40 mm	35 pcs
	Hole	Ø 4.85 mm	
	Material thickness	1.0 mm	



Wood ≤ 15 mm and steel ≤ 0.6 mm constructions

# EUROFAST® Peel Rivet

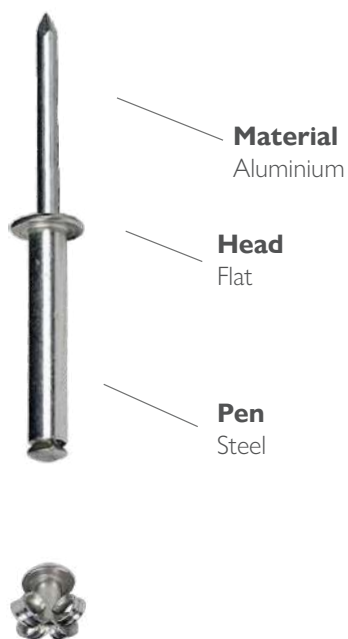

Product key	Clamping	Dimensions		
	mm	Ø	Plug	⊠
1130064025	10	6.4	25	100
1130064038	25	6.4	38	100
* 1130064050	40	6.4	50	500
* 1130064080	70	6.4	80	250
* 1130064100	90	6.4	100	250
* 1130064120	110	6.4	120	250
* 1130064150	140	6.4	150	250
* 1130064175	165	6.4	175	200

\* Delivery-time on request

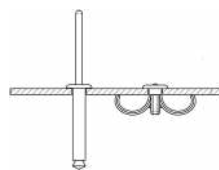
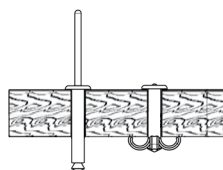

### Pre-drilling

Using a drill diameter of max. Ø 7.0 mm for pre-drilling.

### Static pull-out value

There should be counted with a static pull-out value of 3500N and a shear load of 2450N, tested in accordance with EN ISO14589.

# Universal applications

## Thread protection cap



**Extra option**

Other RAL colors on request.  
Minimum order quantity: 5.000pcs

Product key	Dimensions			
	Ø	Plug	RAL	☒
5040159002	4.0	15	9002	500
5040309002	4.0	30	9002	500
5040159007	4.0	15	9007	500
5040309007	4.0	30	9007	500
5040159010	4.0	15	9010	500
5040309010	4.0	30	9010	500
5040150000	4.0	15	-	500
5040300000	4.0	30	-	500
5060309010	6.0	30	9010	500

## Lead joint clamp

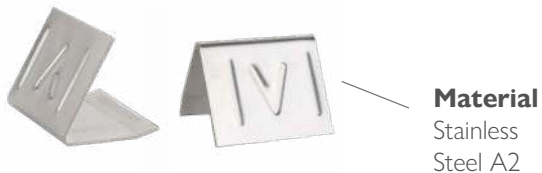

Product key				
				☒
2302000025				25
2302000050				50

## Universal applications

# EUROFAST® Nails



**Material**  
Steel

SHINGLE NAIL Product key	Dimensions			
	Ø	Nail	Weight	☒
RAN-30015-01	3.0	15	1000	979
RAN-30015-05	3.0	15	5000	4895
RAN-30020-01	3.0	20	1000	706
RAN-30020-05	3.0	20	5000	3530
RAN-30025-01	3.0	25	1000	610
RAN-30025-05	3.0	25	5000	3050
RAN-30030-01	3.0	30	1000	501
RAN-30030-05	3.0	30	5000	2505
RAN-30040-01	3.0	40	1000	417
RAN-30040-05	3.0	40	5000	2085
RAN-30050-05	3.0	50	5000	1685



**Material**  
Aluminium

SLATE-NAIL Product key	Dimensions			
	Ø	Nail	Weight	☒
RALN-38060	3.8	60	2000	980
RALN-38065	3.8	65	2000	920
RALN-38070	3.8	70	2000	860
RALN-38080	3.8	80	2000	760
RALN-38100	3.8	100	2000	620
RALN-50125	5.0	125	2000	300



**Material**  
Steel

NAIL TWISTED Product key	Dimensions			
	Ø	Nail	Weight	☒
RTN-38025	3.8	25	1778	1000
RTN-38025-01	3.8	25	1000	560
RTN-38032	3.8	32	2268	1000
RTN-38032-01	3.8	32	1000	440



**Material**  
Stainless Steel A2

NAIL TWISTED Product key	Dimensions			
	Ø	Nail	Weight	☒
RTN-SR-36032-01	3.6	32	1000	540



Universal applications

# EUROFAST® Speedpluggen

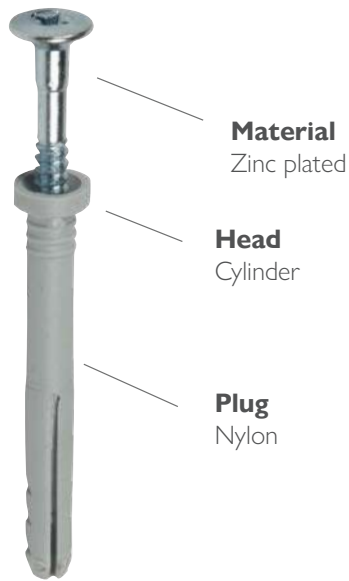

Product key	Dimensions		
	Ø	Plug	⊠
4550005030	5.0	30	200
4550005040	5.0	40	200
4550005050	5.0	50	200
4550006030	6.0	30	200
4550006035	6.0	35	200
4550006040	6.0	40	200
4550006050	6.0	50	200
4550006060	6.0	60	200
4550006080	6.0	80	200
4550006100	6.0	100	100
4550008060	8.0	60	100
4550008080	8.0	80	100
4550008100	8.0	100	100
4550008120	8.0	120	100
4550008140	8.0	140	100

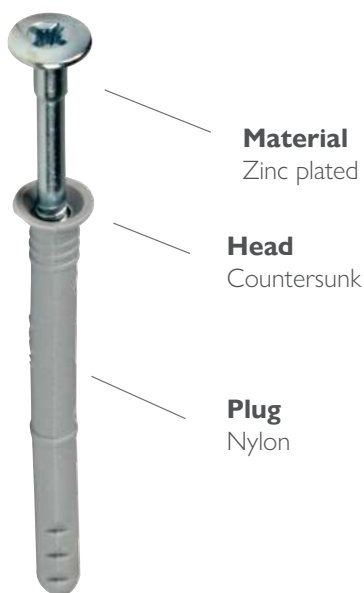

Product key	Dimensions		
	Ø	Plug	⊠
4551006040	6.0	40	200
4551006050	6.0	50	200
4551006060	6.0	60	200
4551006080	6.0	80	200
4551006100	6.0	100	100
4551008060	8.0	60	100
4551008080	8.0	80	100
4551008100	8.0	100	100
4551008120	8.0	120	100
4551008140	8.0	140	100

## Universal applications

# EUROFAST® Butyl Tape

Product key	Description
	2304000004 <ul style="list-style-type: none"> <li>• Butyl Tape 4 mm BEAD</li> <li>• Grey</li> <li>• 12 mtr p/roll</li> <li>• 30 Rolls p/box</li> </ul>
	2304000008 <ul style="list-style-type: none"> <li>• Butyl Tape 6 mm BEAD</li> <li>• Grey</li> <li>• 8 mtr p/roll</li> <li>• 22 Rolls p/box</li> </ul>
	2304000007 <ul style="list-style-type: none"> <li>• Butyl Tape 8 mm BEAD</li> <li>• Grey</li> <li>• 6 mtr p/roll</li> <li>• 22 Rolls p/box</li> </ul>
	2304000001 <ul style="list-style-type: none"> <li>• Butyl Tape 3 mm x 9 mm</li> <li>• Grey</li> <li>• 15 mtr p/roll</li> <li>• 22 Rolls p/box</li> </ul>
	2304000009 <ul style="list-style-type: none"> <li>• Butyl Tape 5 mm x 6 mm</li> <li>• Grey</li> <li>• 9.6 mtr p/roll</li> <li>• 22 Rolls p/box</li> </ul>
	2304000005 <ul style="list-style-type: none"> <li>• Butyl Tape 4 mm x 18 mm</li> <li>• Grey U-shape</li> <li>• 12 mtr p/roll</li> <li>• 16 Rolls p/box</li> </ul>
	2304000010 <ul style="list-style-type: none"> <li>• Polyband 1 mm x 50 mm</li> <li>• White</li> <li>• 35 mtr p/roll</li> <li>• 6 Rolls p/box</li> </ul>

## Universal applications

# Repair Material

Product key	Description
	1602000118 Eurofast steel welding seam roller 40 mm
	2302021000 Roof repair tape white. roll of ± 15 cm x 15.2 mtr
	2302021100 Roof repair tape black. roll of ± 15 cm x 15.2 mtr
	2302021010 Roof repair tape white. roll of ± 30 cm x 15.2 mtr
	2302021110 Roof repair tape black. roll of ± 30 cm x 15.2 mtr
	2302021300 Heavy duty scouring pad, 26 x 12 cm
	2302021400 Heavy duty scouring pad holder
	2302022050 Cleaner, spray-bottle 0.5 Liter

## Tools &amp; Accessories

# EUROFAST® SDS-plus drill

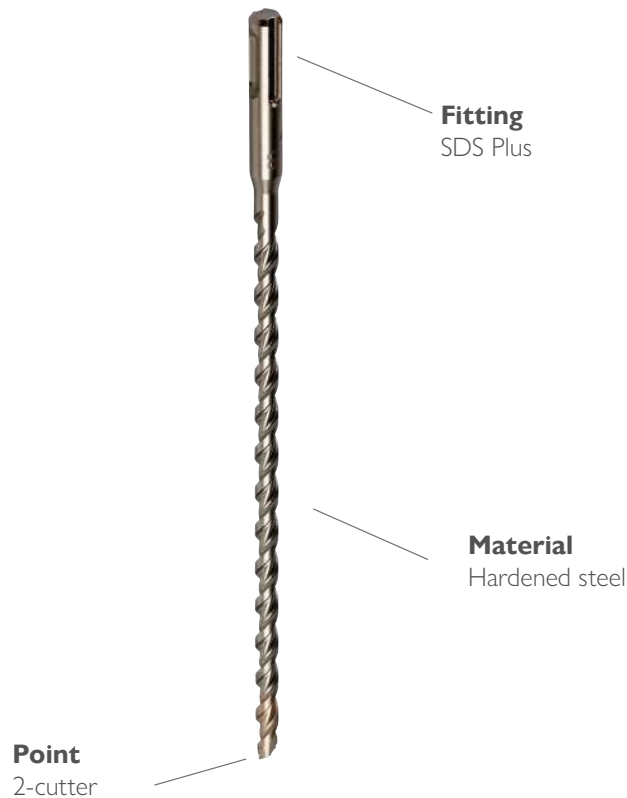

Product key	Dimensions			
	Ø	Total	Effective	☒
0121050110	5.0	110	50	1
0121050160	5.0	160	100	1
0121050210	5.0	210	150	1
0121050260	5.0	260	200	1
0121050310	5.0	310	250	1
0121050410	5.0	410	350	1
0121055110	5.5	110	50	1
0121055160	5.5	160	100	1
0121055210	5.5	210	150	1
0121055260	5.5	260	200	1
0121055310	5.5	310	250	1
0121055350	5.5	350	300	1
0121055410	5.5	410	350	1
0121055600	5.5	600	540	1
0121060110	6.0	110	50	1
0121060160	6.0	160	100	1

Product key	Dimensions			
	Ø	Total	Effective	☒
0121060210	6.0	210	150	1
0121060260	6.0	260	200	1
0121060310	6.0	310	250	1
0121060460	6.0	460	400	1
0121060600	6.0	600	540	1
0121080110	8.0	110	50	1
0121080160	8.0	160	100	1
0121080210	8.0	210	150	1
0121080260	8.0	260	200	1
0121080310	8.0	310	250	1
0121080400	8.0	400	340	1
0121080460	8.0	460	400	1
0121080600	8.0	600	540	1
0121100160	10.0	160	100	1
0121100210	10.0	210	150	1
0121100260	10.0	260	200	1

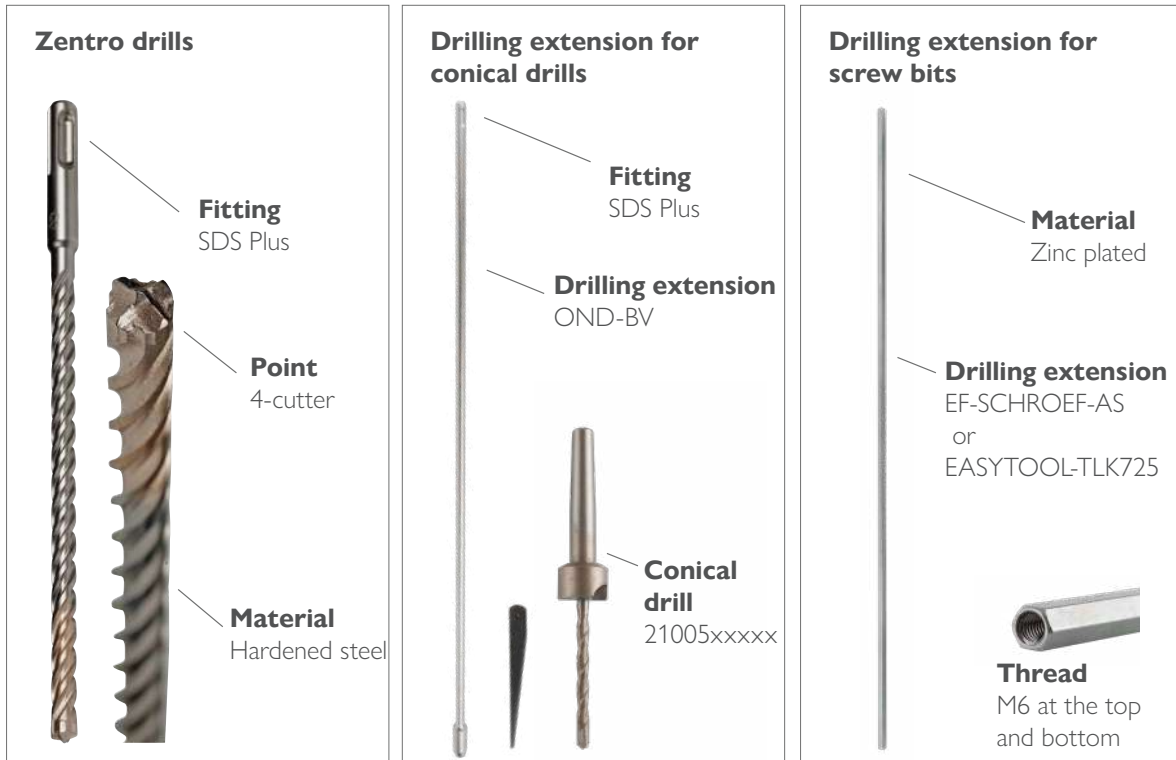

Tools & Accessories

# EUROFAST® 4-cutter & Conical



Product key	Dimensions			
	Ø	Total	Effective	✉
0123060110	6.0	110	50	1
0123060160	6.0	160	100	1
0123080210	8.0	210	150	1
0123080260	8.0	260	200	1
0123080310	8.0	310	250	1
0123080460	8.0	460	400	1
0123080600	8.0	600	540	1

Product key	Dimensions			
	Ø	Total	Effective	✉
2100520001	5.2	92	25	1
2100520002	5.2	102	35	1
2100520003	5.2	122	55	1
2100550001	5.5	92	25	1
2100550002	5.5	102	35	1
2100550003	5.5	122	55	1
2100550004	5.5	160	100	1
OND-BV-650		650		1
OND-BV-800		800		1
OND-BV-1100		1100		1
EF-SCHROEF-AS		745		1
EASYTOOL-TLK725	9.0	725		1

Screw bits	Product key	Dimensions			
		Ø	Type	Insert	✉
	240260502050	6.0	M5	PH2	1
	240260525045	8.0	M6	TX25	1
	240260525065	8.0	M6	PH2	1
	240260525050	9.35	M6	TX25	1
	240260525055	9.35	M6	PH2	1

## Tools &amp; Accessories

## EUROFAST® Tool bits



Bitholder Product key	Type		☒
	Type	☒	
240201414300	Felo High impact	☒	1
240201414100	Magnetic	☒	1
240201414200	Magnetic spring	☒	1
240200000207	Universal SDS+	☒	1
240201414302	Universal 1/4 quick lock	☒	1



PHILIPS Product key	Dimensions			☒
	Type	Length	☒	
240211401025	PH1	25	☒	1
240211402025	PH2	25	☒	1
240211402050	PH2	50	☒	1
240211402150	PH2	150	☒	1
240211402250	PH2	250	☒	1
240211402300	PH2	300	☒	1
240211402350	PH2	350	☒	1
240211403025	PH3	25	☒	1
240211403050	PH3	50	☒	1
240211403150	PH3	150	☒	1
240211403250	PH3	250	☒	1



POZIDRIVE Product key	Dimensions			☒
	Type	Length	☒	
240221401025	PZ1	25	☒	1
240221402025	PZ2	25	☒	1
240221403025	PZ3	25	☒	1

## Tools & Accessories



TORX Product key	Dimensions		
	Type	Length	☒
240231420025	TX20	25	1
240231425025	TX25	25	1
240231425050	TX25	50	1
240231425150	TX25	150	1
240231425250	TX25	250	1
240231425300	TX25	300	1
240231425350	TX25	350	1
240231430025	TX30	25	1
240231430050	TX30	50	1
240231440025	TX40	25	1



ROBERTSON Product key	Dimensions		
	Type	Length	☒
240251402025	R2	25	1
240251402050	R2	50	1
240251403025	R3	25	1
240251403050	R3	50	1



HWH Product key	Dimensions	
	Type	☒
240271438000	HWH 3/8	1
240271408000	HWH 8 mm	1
240281408000	HWH 8 mm	1
240281410000	HWH 10 mm	1
240281401400	HWH 1/4 mm	1
240281403800	HWH 3/8 mm	1
240281405160	HWH 5/16 mm	1

*Magnetic  
toolbits*

## Tools &amp; Accessories

## EUROFAST® HQ Tool bits



Toolbit-set

PHILIPS Product key	Dimensions		
	Type	Length	☒
240111402025	PH2	25	1
240111402050	PH2	50	1
240111402150	PH2	150	1
240111402250	PH2	250	1
240111403025	PH3	25	1
240111403050	PH3	50	1
EF-BITSETPH2HQ25	PH2	25	10
EF-BITSETPH2HQ50	PH2	50	10
EF-BITSETP2HQ150	PH2	150	5
EF-BITSETP2HQ250	PH2	250	5
EF-BITSETPH3HQ25	PH3	25	10
EF-BITSETPH3HQ50	PH3	50	10



Toolbit-set

POZIDRIVE Product key	Dimensions		
	Type	Length	☒
240121402025	PZ2	25	1
240121402050	PZ2	50	1
240121403025	PZ3	25	1
240121403050	PZ3	50	1
EF-BITSETPZ2HQ25	PZ2	25	10
EF-BITSETPZ2HQ50	PZ2	50	10
EF-BITSETPZ3HQ25	PZ3	25	10
EF-BITSETPZ3HQ50	PZ3	50	10



## Tools & Accessories



TORX Product key	Dimensions		
	Type	Length	☒
240131420025	TX20	25	1
240131420050	TX20	50	1
240131425025	TX25	25	1
240131425050	TX25	50	1
240131425150	TX25	150	1
240131425250	TX25	250	1
240131425300	TX25	300	1
240131430025	TX30	25	1
240131430050	TX30	50	1
240131440025	TX40	25	1
240131440050	TX40	50	1

Toolbit-set	Dimensions		
	Type	Length	☒
EF-BITSETT20HQ25	TX20	25	10
EF-BITSETT25HQ25	TX25	25	10
EF-BITSETT25HQ50	TX25	50	10
EF-BITSET25HQ150	TX25	150	5
EF-BITSET25HQ250	TX25	250	5
EF-BITSET25HQ300	TX25	300	5
EF-BITSETT30HQ25	TX30	25	10
EF-BITSETT30HQ50	TX30	50	10
EF-BITSETT40HQ25	TX40	25	10
EF-BITSETT40HQ50	TX40	50	10



ROBERTSON Product key	Dimensions		
	Type	Length	☒
240151402050	R2	50	1

## Ergonomic installation equipment

# EUROFAST® DEK-FIX



Instructional video

**Material**  
Lightweight  
construction

**Depth-control**  
Max. Screw  
length 240 mm



**Screw bit**  
HWH 8 mm  
OND-DFX-6.1.6



### Application

Machine processing for belted fasteners: EDS-BGT, EDS-BGTHD and EDS-BGTR.

### Transport chest

The Eurofast® DEK-FIX comes in a transport chest including a toolkit and manual. Please visit [www.eurofastgroup.com](http://www.eurofastgroup.com) for the user instruction.

## Ergonomic installation equipment

# EUROFAST® EURO-FIX



Instructional video

**Depth-control**  
Max. build-up  
260 mm



**Material**  
Lightweight  
construction

**Screw bit**  
TX25 M6  
240260525050  
PH2 M6  
240260525055



### Application

Machine processing for belted tube washer combinations: TRPSG-45, TWPSG-45, TRPBG-45, TWPSB-45, TRPSRBG-45, TRPHG-45 and TWPHG-45.

### Transport chest

The Eurofast® EURO-FIX comes in a transport chest including a toolkit and manual. Please visit [www.eurofastgroup.com](http://www.eurofastgroup.com) for the user instruction.

## Ergonomic installation equipment

# EUROFAST® SINGLE-FIX



Instructional video



**Depth-control**  
Max. drilling depth  
400 mm

**Material**  
Lightweight  
construction

**Hammer drill**  
1x type Hitachi DH28P

**Hose**  
Incl. 10 mtr

**Motor**  
620 W power

**Specially designed  
extraction system**

**Weight**  
14.84 Kg

**Capacity**  
15L

### Transport chest

The Eurofast® SINGLE-FIX comes in a transport chest including dust extractor and manual.

Please visit [www.eurofastgroup.com](http://www.eurofastgroup.com) for the user instruction.

## Ergonomic installation equipment

# EUROFAST® TRIPLE-FIX

**TNO** innovation  
for life



Instructional video



**Depth-control**

Max. drilling depth  
400 mm

**Material**

Lightweight  
construction

**Hammer drill**

3x type Hitachi DH28P

**Hose**

Incl. 10 mtr



**Specially designed  
extraction system**

**Weight**

14.84 Kg

**Capacity**

15L

**Motor**

620 W power



### TNO certification

The Eurofast® TRIPLE-FIX is TNO tested and has obtained the official TNO certification.

### Transport chest

The Eurofast® TRIPLE-FIX comes in a transport chest including dust extractor and manual.

Please visit [www.eurofastgroup.com](http://www.eurofastgroup.com) for the user instruction.

# Ergonomic installation equipment

## EUROFAST® EASYTOOL-TRP-TWP



**Adapter**  
ET-ADAPT-MAKITA



ET-ADAPT-HITACHI



ET-ADAPT-HILTI



ET-ADAPT-WURTH



**Extra option**

Eurofast® Belt pouch  
TPP-GORDEL



# Ergonomic installation equipment

## EUROFAST® EASYTOOL-TLK



**Adapter**  
ET-ADAPT-MAKITA



ET-ADAPT-HITACHI



ET-ADAPT-HILTI



ET-ADAPT-WURTH



**Extra option**

Eurofast® Belt pouch  
TPP-GORDEL



Ergonomic installation equipment

# EUROFAST® EASYTOOL-PRO



Instructional video

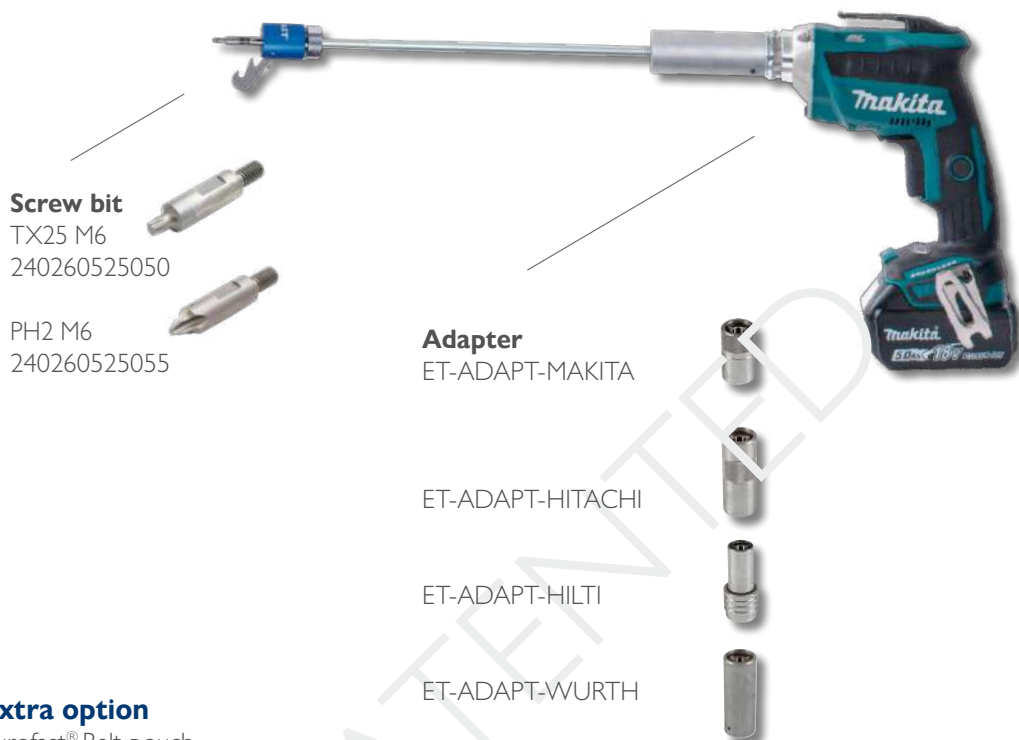

**Screw bit**  
TX25 M6  
240260525050

PH2 M6  
240260525055

**Adapter**  
ET-ADAPT-MAKITA

ET-ADAPT-HITACHI

ET-ADAPT-HILTI

ET-ADAPT-WURTH

**Extra option**

Eurofast® Belt pouch  
TPP-GORDEL



**Not suitable for fixation into concrete.**



Eurofast® TRP-45



Eurofast® TLK-45



Eurofast® TLK-75



# Ergonomic installation equipment

## EUROFAST® SHORT TOOL



### Extra option

Eurofast® Belt pouch  
TPP-GORDEL



OND-DF-SHORT (PH3)  
5.5 / 6.0 / 6.7 mm

**Toolbit**  
240211403050

OND-EF-SHORT (PH2)  
4.8 mm

**Toolbit**  
240211402050

OND-BZ-SHORT (HWH8)  
4, 8 mm

**Toolbit**  
240281408000

EF-EXTENS  
Universal extension

## Ergonomic installation equipment

# EUROFAST® Rivet tools



### Extra option

Models on request

# EUROFAST® For creating holes

### Application

For poking holes in multiple layered roofing membranes. To use on renovation projects with tube washer combinations.

VOORPRIKKER

